

Pagliacci

1976

Wednesday, October 27, 1976 8:00 PM
Saturday, October 30, 1976 1:30 PM
Friday, November 5, 1976 8:00 PM (Broadcast)
Wednesday, November 10, 1976 8:00 PM
Saturday, November 13, 1976 8:00 PM
Tuesday, November 16, 1976 8:00 PM
Sunday, November 21, 1976 2:00 PM
Wednesday, November 24, 1976 8:00 PM
Saturday, November 27, 1976 8:00 PM

SFO_PUB_01_SFO_1976_08

Publications Collection

San Francisco Opera Archives

Cavalleria Rusticana and I Pagliacci

SAN FRANCISCO OPERA MAGAZINE 1976



"My Marantz stereo is built strong as a bloomin' tank!"



"I've got a lot of respect for Marantz' first-rate construction. In my establishment my Marantz stereo system is goin' all the time, year in, year out. And because Marantz builds receivers with nothin' but the best materials, they're as dependable and rugged as the Highland Regulars. But it's the sound that stirs the heart. Especially with the built-in **Dolby Noise Reduction System.*** You can use it to silence noise on tapes, records, even FM Dolbyized radio programs. The Marantz sound is so ruddy real that listenin' to the pipers playin' makes me feel like I was back with my old regiment chasin' the Desert Fox."



London pub owner Sergeant Major (Ret.) Harry Driscoll owns a Marantz 2325 AM/FM stereo receiver. 125 watts continuous power per channel at 8 ohms from 20 Hz to 20 kHz with no more than 0.1% total harmonic distortion. See the complete Marantz line starting as low as \$299.95 at your Marantz dealer.

All over the world
people consider Marantz Stereo
the finest in the world.

marantz®
We sound better.



Dolby is a trademark of Dolby Labs, Inc.
© 1976 Marantz Co., Inc., a subsidiary of Superscope, Inc., 20525 Nordhoff St., Chatsworth, CA 91311. In Europe: Superscope Europe, S.A., Brussels, Belgium. In Canada: Superscope Canada, Ltd., Ontario. In the Far East: Marantz Far East, Tokyo, Japan. Prices and models subject to change without notice. Consult the Yellow Pages for your nearest Marantz dealer.



I always drink Cuervo Gold. Now & then.

Cuervo Especial. Tastes somewhere between the smooth of scotch and the mellow of really good cognac.

When you're feeling a bit bored by your usual — try it on the rocks. If you're more bored than usual — try it in a snifter.

Of course, when you raise your glass, you'll also raise a few eyebrows. But surely you've done that before.



Try it with soda.



Catherine Deneuve for Chanel

CHANEL N°5

Perfume in the classic bottle 12.50 to 400., Spray Perfume 9.50, Eau de Toilette 8.00 to 22.00, Eau de Cologne 6.00 to 27.50, and Spray Cologne 8.00.

Cavalleria Rusticana and I Pagliacci

SAN FRANCISCO OPERA MAGAZINE 1976



A Message from the
General Director 7

Non-Naturalistic Illusions: The
Directing Techniques of
Jean Pierre Ponnelle 11
by Paul Chaplin

Ninety Years Later and
Still Verismo 18
by Gary Schmidgall

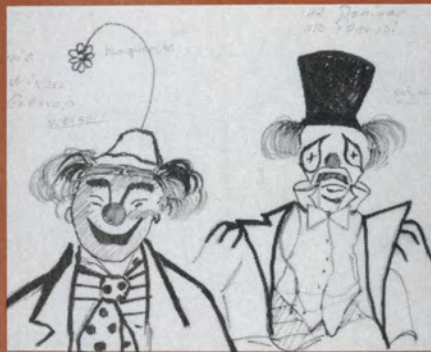

Season Repertoire 39

Special Events 41

The Program 47

Box Holders 53

Guarantor Members 55

San Francisco Opera Fund Drive 61

Artist Profiles 64

On the Staff 74

Calendar for the 54th Season 86



San Francisco Opera Magazine 1976 is a Performing Arts publication, Michel Pisani, Publisher; Jerry Friedman, Editor and General Manager; Olga Trento, Managing Editor. © All rights reserved 1976 by Performing Arts. Reproduction from this magazine without written permission is prohibited. Performing Arts—S.F. Office: 651 Brannan St., San Francisco, California 94107. Telephone (415) 781-8931; L.A. Office: 9348 Santa Monica Boulevard, Beverly Hills, California 90210. Telephone (213) 274-8728. Printed in San Francisco.

Cover Photo: Ron Scherl

Art Direction: Browning Graphics

Close your eyes and imagine an island
in the South Pacific.

Is this what you imagined?

New Zealand's Southern Alps. Austria, 7,000 miles into the South Pacific! Light little ski planes wait to sail you 8,000 feet up for a stroll on the Tasman Glacier.



Christchurch. Straw boaters, school ties and blazers in a South Pacific better known for bikinis and grass skirts!



If the usual island tourist hustle seems far away here in New Zealand, it is!



Milford Sound. Serene, mist-swirling, rainbowed—all within a couple of hours! Is this the South Pacific? Or is it Scandinavia? To see Milford and all of the South Pacific you never imagined, plan on staying a couple of weeks with the friendly New Zealanders.



Afternoon tea and bowling in Rotorua.

Not far off is a misty moonscape, bubbling, geysering and sacred to the first New Zealanders—the Maoris.



NEW ZEALAND

(A South Pacific you never imagined.)

NEW ZEALAND GOVERNMENT TOURIST OFFICE
One Maritime Plaza, Suite 970, San Francisco, CA 94111
630 Fifth Avenue, New York, N.Y. 10020
10960 Wilshire Blvd., Los Angeles, CA 90024

Send me more on a South Pacific I never imagined.

Name _____

Address _____

City _____

State _____ Zip _____

*PRA 10-6SF



Welcome to San Francisco Opera's 1976 season.

As you wait for the curtain to rise, we would like to point out to you several improvements: many seats have been reupholstered, a new floor covers a large part of the stage, and all our productions will benefit from a new and sophisticated light board. The foregoing is a clear indication that physical restoration and updating of the Opera House has begun. Furthermore, the Opera has concluded its part in the planning of the new Performing Arts Center. Provided that the financial means can be found and the proper decisions made, we dare to hope that construction of the backstage addition to the opera house may start in the very near future.

For the first time, we are using the pit extension, an original feature of our building; you will now hear operas performed with their original orchestration.

Our 54th season will be remembered for many notable events; preeminent among them will be a meeting in early November of the International Association of Opera Directors. Many of my distinguished colleagues, representing the leading opera houses of the world, will meet in our city to attend the world premiere of *Angle of Repose*; they will be joined by representatives of OPERA America, our own country's association of opera managers, and by heads of the National Endowment for the Arts and the National Opera Institute.

The hundreds who perform on stage, backstage, in the pit, in the offices, opera professionals from many nations are ready to give the best of their talent to our '76 season. Let me thank them warmly for their sincere dedication and may you, our audience, enjoy and support their efforts.

ALFRED DUNHILL LTD. LONDON



Internationally acknowledged

Dunhill International. Created by our
blenders from tobaccos of exceptional
quality to be the world's finest cigarette.

dunhill

The most distinguished tobacco house in the world

Warning: The Surgeon General Has Determined
That Cigarette Smoking Is Dangerous to Your Health.

25mg. "tar," 1.5mg. nicotine av. per cigarette, by FTC method.

In Recital

The hold of Leontyne Price, the great American soprano, on San Francisco Opera audiences is uncontested and unique. Ever since her first season here in 1957 when she sang in *The Dialogues of the Carmelites* and *Aida*, San Franciscans have taken Miss Price to their hearts and basked in all her subsequent performances in *Don Giovanni*, *Il Trovatore*, *Il Tabarro*, *La Forza del Destino*, *Un Ballo in Maschera*, *Turandot*, *Madama Butterfly* and *Ernani*.

This season, on November 21, San Francisco Opera will again present Miss Price, but in her other guise, as a recitalist, for which she has also won the highest possible acclaim.

Last year Miss Price gave a concert at the Salzburg Festival which prompted the critic from the Frankfurter Allgemeine to say in his review that "La Price can do everything which her will wants her to express. A program like this one shows her as a phenomenon of expressivity and changing, transitional moods . . . what incredible variety of colors she draws from her voice."

The Vienna Kurier's critic Karl Löbl chimed in "the voice of Leontyne Price is more beautiful than ever. She gives the impression of a valuable instrument on which she plays like a virtuoso. The voice . . . under complete control with infallible instinct for color values. Singing can be the most human of all music-making: Leontyne Price once more demonstrated it."

After her San Francisco recital of last year Heuwell Tircuit of *The Chronicle* also claimed that "the singing, the voice and the intellect of La Price are at their zenith. (her) Schubert was superlative. (her) Tchaikovsky and Rachmaninoff were memorable."

Tickets for the upcoming November 21 recital are available now at the Opera Box Office, 431-1210. Prices range from \$5 to \$15, with a few box seats available at \$18.



There's a simple virtue that separates the extraordinary from the ordinary.

Dedication.

The kind of dedication that produces the identifiable excellence that makes

Beefeater® Gin,
Beefeater Gin.



One good performer appreciates another.

U.S. Steel people know a good performance when they see one. Having sharpened the skills they bring to their own jobs, they appreciate talent in other fields such as the performing arts. Wherever they live and work, they support plays, musicals, the opera, ballet and choral and orchestral performances through their own efforts, and help to generate the support of others.

Whatever the cultural activity, the contribution of U.S. Steel's men and women is a significant

element in communities where our plants and offices are located.

So whenever you hear applause for a fine performance in Pittsburgh, or Chicago, or in Washington, Cleveland, Birmingham, Gary, Houston, Salt Lake City or San Francisco, you can be sure that U.S. Steel people are not only joining in it, but that they helped the performers win that applause.



We're involved.

TRADEMARK

Non-Naturalistic Illusions: The Directing Techniques of Jean Pierre Ponnelle

by Paul Chaplin

It's the first time Jean Pierre Ponnelle has seen his set for *Cavalleria Rusticana*. In a few minutes the San Francisco Opera chorus will arrive for its initial rehearsal with the famed direc-

tor-designer. "It's hard to come to this after Mozart," he muses, looking the set over. He had landed at San Francisco International Airport eighteen

continued on p. 12

Jean Pierre Ponnelle (right) ponders a scenic problem with San Francisco Opera technical director John Priest.

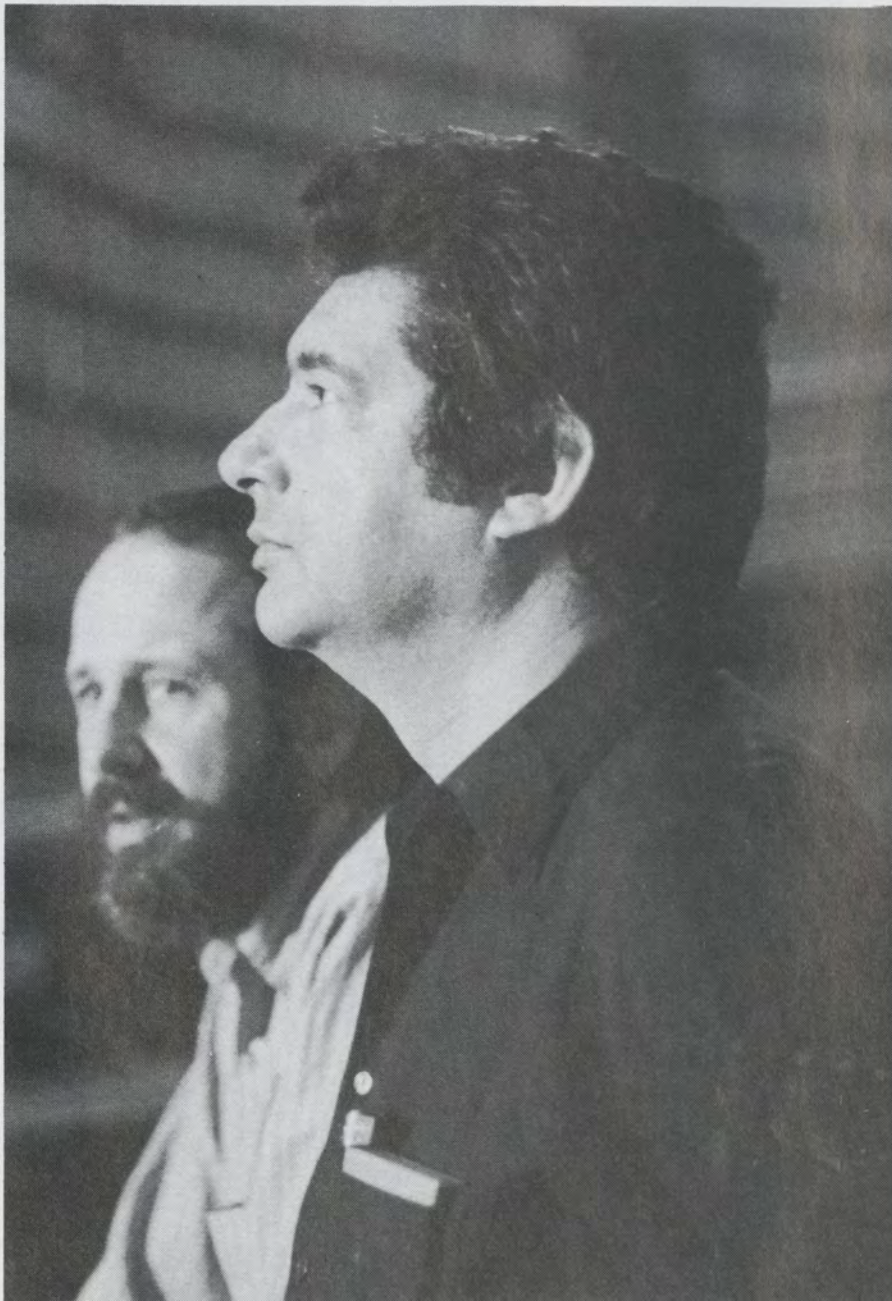

Photo: Caroline Crawford



**Think of it
as
investment
spending.**



Eau de Toilette
After Shave Lotion
Bath Soap
Shaving Foam
Protein Shampoo
Spray Talc

Jean Pierre Ponnelle
continued from p. 11



**"A little
more coffee, then
let's watch the
sunrise."**

Good food served twenty-four hours
a day. Cocktails, 10 a.m.-2 a.m.

Brasserie
At The Fairmont, Atop Nob Hill

hours ago after a brief visit to Paris, following his stagings of *Così fan tutte* and *La Clemenza di Tito* in Salzburg.

He examines the false proscenium arch and comments, "We must first check where the best sound comes from." No sooner has he spoken than the chorus arrives on stage, summoned from the labyrinthian corridors of the downstairs dressing rooms and

lounges. As though planned, choristers walk onto the set, forming a line across the stage with their backs to the director, as they too encounter the set for the first time.

Gradually the chorus starts walking around the set and sitting on parts of a stone wall downstage. Kurt Herbert Adler, general director of San Francisco Opera, steps onstage, pausing

On the *Cavalleria* and *Pagliacci* set, director Jean Pierre Ponnelle shows an assistant how he wants things done.



**Royal Gate
Vodkahn.**

Truly "ahh'mazing."

80 Proof. Distilled from Grain. Royal Gate Co., San Francisco.

to speak with a few people before introducing Ponnelle to the chorus.

Why is Ponnelle, perhaps the most sought-after creative talent in the operatic world today, staging *Cavalleria Rusticana* and *I Pagliacci*, the popular double-bill of verismo opera?

"I must say that it's not my idea; it was Kurt Adler's idea to invite me to

do it. I've never done a verismo Italian opera before, so I'm very interested in doing it. It's a challenge to me.

"I think attempting to create the perfect illusion of life onstage is an illusion itself. I do not think it is possible; it's nonsense. The stage is an illusion, and to present an illusion of life onstage is a double; it's a redundancy.

continued on p. 14

Photo: Caroline Crawford



The book that can brighten Your Financial Future.



**YOU NEED IT NOW:
343-page
Estate Planning
Guide.**

FREE!

The complete, easy-to-read, non-technical guide to creating and maintaining an estate you can live with. Learn how to accumulate capital and put it to work for you, secure your family against illness and disability, and protect your estate from unnecessary taxation.

Bring this ad with you for your free copy!

CITIZENS SAVINGS
AND LOAN ASSOCIATION

Over 70 offices throughout California.

Over \$1.7 billion strong.

Rare taste.
We found a way
to bottle it.



For more than 225 years, the House of Justerini & Brooks has been one of London's leading wine and spirit merchants. During that time, our reputation for quality and integrity has become legend. It is a heritage that helps make J & B very rare scotch indeed.

J&B
RARE
SCOTCH

86 Proof Blended Scotch Whisky
© 1976 Paddington Corp., N.Y.

continued from p. 13

It's not interesting, and technically it's quite impossible. To do the perfect illusion of life you need three or four months of rehearsal and that is impossible. What I am trying to do is to use some aphoristic, concrete, real information in the staging. I think the operas are tragedies, and tragedy is a form of art, not a form of naturalistic illusions."

Ponnelle finds his directional inspiration comes from the music of the operas. "The first thing I always do when working on an opera is to get deeply involved with the music. Original sources, like the short story by Verga which was the idea for Mascagni's *Cavalleria*, are a valuable aid for a director. They can also be dangerous; for example, I don't think it's very important to know the Beaumarchais play, but if you know it, you must forget it and remember you are directing *Le Nozze di Figaro*. Music is much more important than going back to the original source."

Watching the director at work, one wrongly assumes he had training in dance. "I think body expression is a part of theater, a part of stage expression. A lot of people are not conscious of the power of body movement. I don't think it's a question of having a dance background; it's a question of logic between your brain and your legs."

When directing, Ponnelle frequently rushes to a singer to indicate a movement he wants. "I have a precise concept, and with different individuals,

the expression will naturally be different. I show the actors what I want and sometimes they are able to add to it from their own personalities. That is very exciting for a director to see.

"I usually show the actors a caricature of what I want, an exaggeration of what they have to do, because it's easier for them to understand if I exaggerate. Then everybody must find a private way to create the same expression."

Ponnelle does not feel his directing and concept of a production are gimmicky. "I think theater is a show place and one must show a confrontation between dramatic and human things. I believe in this exaggeration of the relationship. I'm not interested in showing people on a bus or sitting in a bar. We always see things on a different level onstage; the relationship of what is happening onstage and what is happening in real life is exaggerated."

Ponnelle has taken *Cavalleria Rusticana* and *I Pagliacci* and staged them in a unified setting in Sicily, updating the time of the action to the early twentieth century. He finds the operas to be very similar. "They are both typical southern Italian Catholic dramas. In *Cavalleria* I will show the big power of religion. The people are conscious of religion, but not how their lives in the village are affected by their Catholic education. Santuzza is pregnant and is looked upon as though she were the plague. I think

this belief system is still held in Italy and in a lot of other countries."

The director-designer believes in freeing opera from conventionalities which have kept staging techniques stagnant for many years. "Conventions are always conventional, so they are boring. When you stage a production, the first thing you must do is forget every kind of tradition. You must read the score and rethink the piece.

"I don't see much difference between *Pagliacci* and *Cavalleria*. I think *Cavalleria* is much more naive, but more sincere than *Pagliacci*. There is much more truth in the Mascagni work and a stronger sense of southern Italy. *Pagliacci* has more theatrical effects, which is what disturbs me about it; the naive folkloristic atmosphere of *Cavalleria* is absent in *Pagliacci*. The idea of a theater within a theater is an old trick; there's little that's new in the opera. What is exciting is the incredible power of the simplicity of the brutality."

Does that mean Ponnelle will produce a brutal production of *Pagliacci*?

"Brutal, yes, but Canio kills Nedda on-stage, and although I have no experience of this sort, I'm certain that when you kill someone it's never very sweet."

When asked to compare San Francisco Opera audiences to others he has encountered, Ponnelle is genuinely complimentary. "The education that Kurt Herbert Adler has given this town in

continued on p. 16

Take an
Interior
Designer
to lunch!

And top it
off with a
visit to the
nearest
McGuire
Showroom.
In San
Francisco
at Jackson
Square.



SEATTLE, PORTLAND, LOS ANGELES, CHICAGO, CLEVELAND, BOSTON,
NEW YORK, MIAMI, ATLANTA, DALLAS, DENVER. ALSO: GREAT BRITAIN,
GERMANY, FRANCE, ITALY, GREECE AND SWITZERLAND.

Our own John Pollia designs a Natural Canadian Lynx jacket smartly trimmed in wool.



Schneider Bros.
Furs.

251 post street

continued from p. 15



oursome

To be internationally acknowledged and instantly associated with the world of golf comes as no surprise to us. It is, rather, the differences between just any "lodge" and The Del Monte Lodge that people sometimes overlook. Golf, yes — on your choice of three of the world's most challenging courses. Tennis on the thirteen courts of the exclusive Beach & Tennis Club. Riding at the Pebble Beach Equestrian Center — regarded as the finest in the west — on 34 miles of magnificent bridle paths. Jogging or hiking on five different trails. Even shooting at the Pebble Beach Trap & Skeet Club. And no matter what your sporting inclinations, you'll find — as with all facets of life at the Lodge — the Del Monte Lodge an experience. And the experience, a pleasure.

the last twenty-five years makes San Francisco audiences, for me, one of the best audiences in the world. The audience is very open, not fixed in a tradition. San Franciscans are also very smart and very quick. The audience is reacting whether they are applauding or not. It is very important to feel the contact with and reaction of an audience, and that is not the same as when the curtain goes up and the setting is all gold and everybody cries 'bravo.' That is uninteresting. The way this city's audiences react from measure to measure is fantastic."

Ponnelle's method of allowing the music to dictate the direction of the opera is for contemporary audiences and not for a place in the history of operatic directing. "I direct for the people who have come here and paid their money to see a show. Theater is for the audience and nobody else. It's not for myself. I must say, a lot of



Del Monte Lodge at Pebble Beach
(California 93953)



Mario Valentino

leather goods/shoes/handbags 1459 Polk Street 673-4460

audiences have found my work controversial, but the reaction was logical. Here in San Francisco, I can try any experiment and the audience will try to follow me with great objectivity, great imagination, and great sensitivity as well. I can do productions here that are impossible to do in, let's say, New York or Milan. I'm very proud of my productions of *Rigoletto* and *Der Fliegende Holländer*, although I am sure my concept of *Holländer* would be scandalous at Bayreuth and my *Rigoletto* would scandalize La Scala. That's not important, for I feel that what I'm doing is right. I don't know if everything was right, but I'm trying to give new life to these operas of the conventional repertoire. That's one of my duties in this business and I'm very glad I have the opportunity to do that here."

Paul Chaplin is the staff writer for San Francisco Opera.



BRITEX SALUTES THE OPERA!
(MANY AN OPENING NIGHT
WAS PRECEDED BY A DAY AT BRITEX.)

BRITEX FABRICS/146 GEARY STREET/147 MILDEN LANE

Ninety Years Later and Still Verismo

by Gary Schmidgall

Original design by Jean Pierre Ponnelle for *I Pagliacci*.

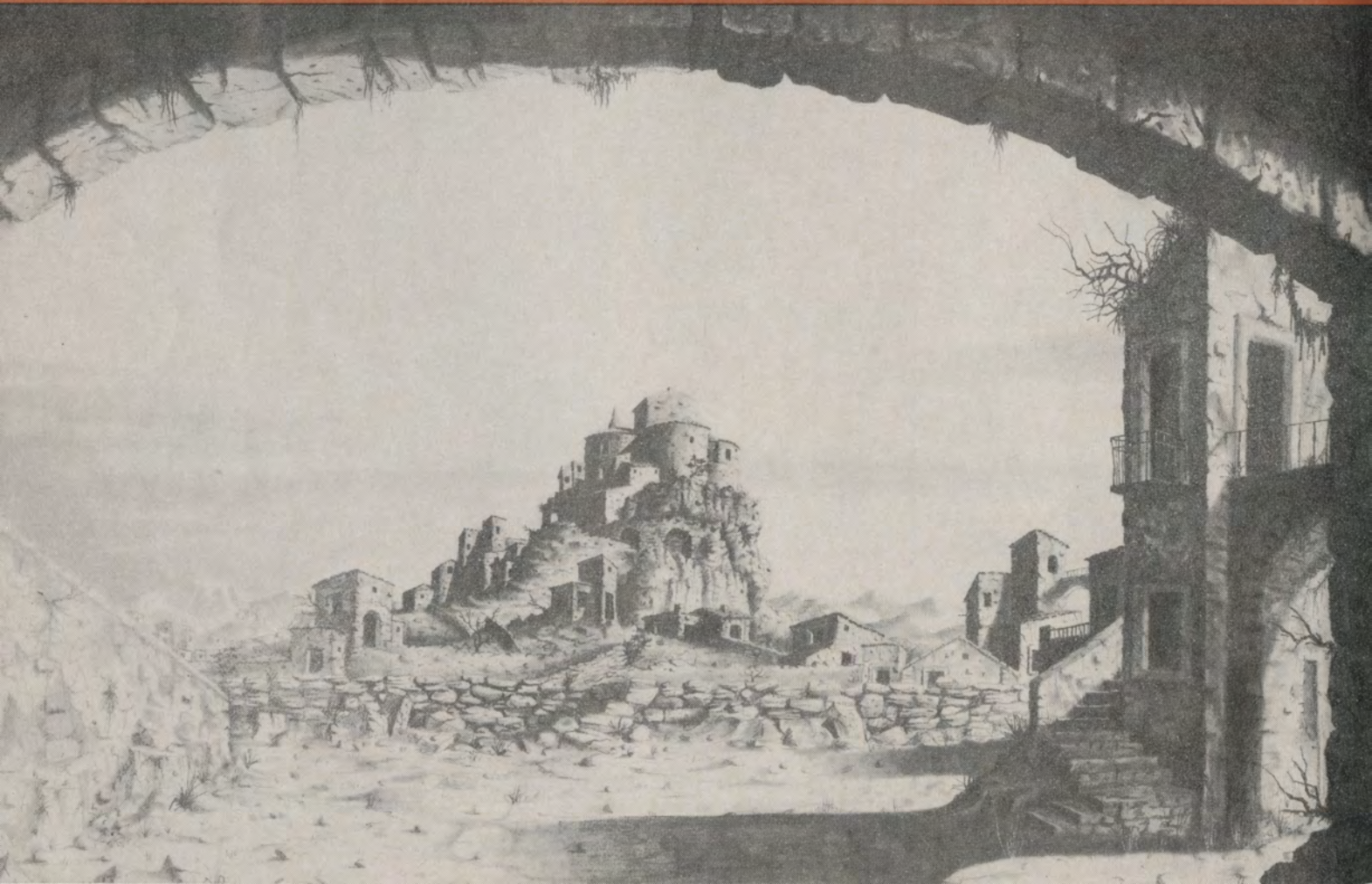

The thrust of nineteenth-century opera—at first Romantic, then Wagnerian—was otherworldly and not tied to the realities of daily life as it is lived by average or low-born people. *Verismo* opera—of which *Cavalleria Rusticana* and *Pagliacci* are prime examples—represented a reaction against this tradition. In its realistic plots and characters, concision and quick pacing, and rejection of elaborate (Wagnerian) compositional artifice, *Verismo* style carried opera into the twentieth century. *Cavalleria* and *Pagliacci* were, and still are, the perfect antidote for *Parsifal*.

Social truth concerned the *veristi*. When Tonio declares in the prologue to *Pagliacci*, “Our author has tried to paint you a slice of life,” he is announcing a central *verismo* artistic principle. (Tonio’s phrase *uno squarcio di vita* is near translation of *une tranche de la vie*, the battle cry of the great French realists.) It is perhaps hard for us today, however, to see *Cav* and *Pag*—lovable, garlicky, familiar warhorses—in their original *verismo* starkness, familiarity breeding not contempt, but forgetfulness of the social realities upon which they were originally founded. This is unfortunate because the social “truth” underlying these two operas remains much the

continued on p. 20

Original design by Jean Pierre Ponnelle for *Cavalleria Rusticana*.



Photo: Caroline Crawford

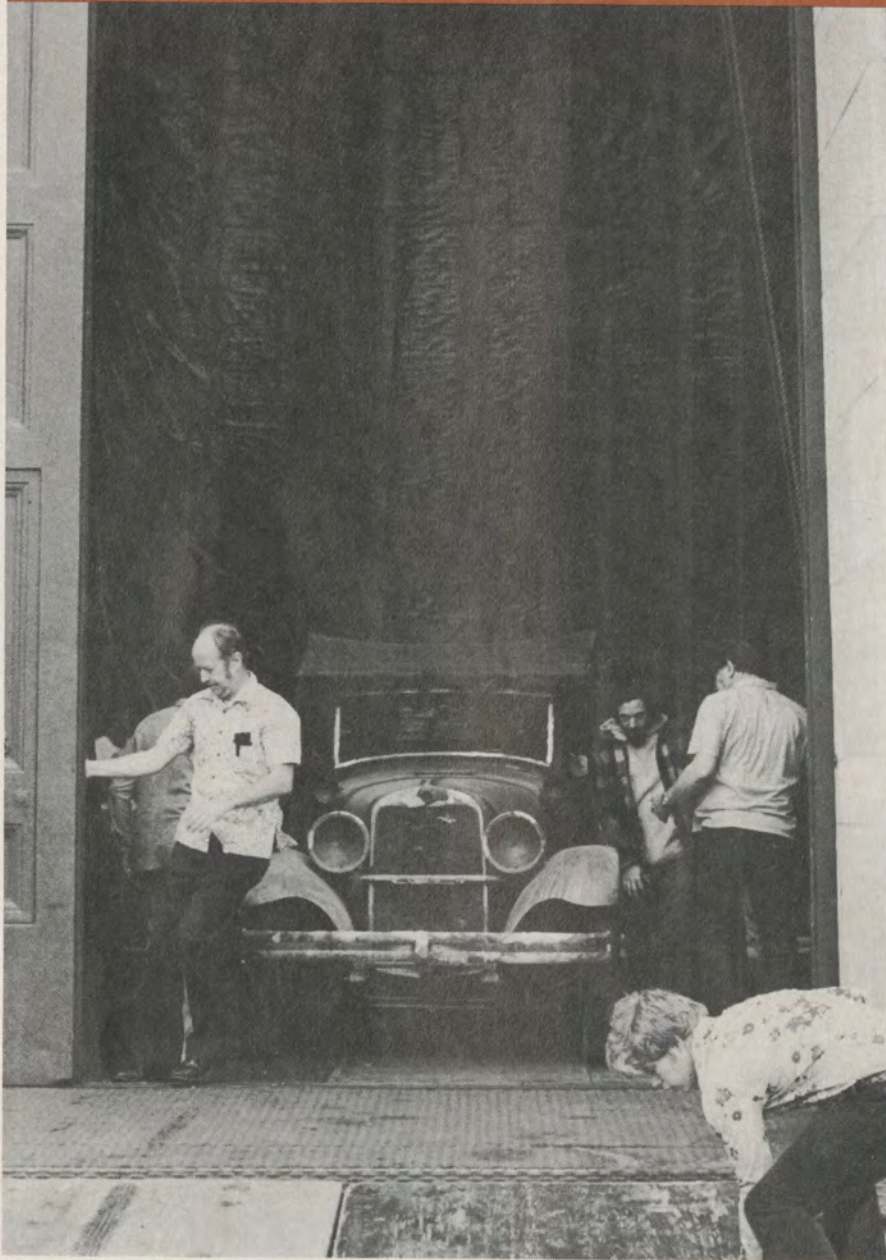

An ancient Chevrolet enters the Opera House (under the supervision of property master Ivan Van Perre at left) to make its debut in the new *I Pagliacci* production.

same to this very day. Sadly and incredibly, the quality, the mainsprings of life in Southern Italy and Sicily have changed but little in the ninety years since Mascagni and Leoncavallo wrote their operas. What was *verismo* in the 1890s is still *verismo* in 1976.

This point is vividly made in *Women of the Shadows* (Atlantic-Little, Brown; 1976)* by Ann Cornelisen. In this book

Cornelisen — an American who has worked for Save the Children in Southern Italy for over two decades — records how peasants live and suffer in the sunburnt, chronically depressed country below Naples where *Cavalleria* and *Pagliacci* take place. From this collection of sensitive real-life portraits I have chosen several passages

continued on p. 22

**SEE US FOR A TEST DRIVE
OR FOR AUTHORIZED VOLVO
PARTS AND SERVICE:**

BERKELEY

H. W. McKeivitt, Inc.
2611 Shattuck Avenue
(415) 848-2206

FREMONT

Pierotti Fremont Imports
35018 Fremont Blvd.
(415) 797-4100

HAYWARD

Hayward Auto Imports
20095 Mission Street
(415) 278-8600

LOS GATOS

Los Gatos Datsun-Volvo
15166 Los Gatos Blvd.
(408) 358-1981

OAKLAND

Ray Cokeley
3000 Broadway
(415) 893-2535

OAKLAND

Continental Volvo, Inc.
4030 East 14th Street
(415) 532-3778

PALO ALTO

Peninsula European, Inc.
4190 El Camino Real
(415) 493-7160

SAN CARLOS

Premier Volvo
281 El Camino Real
(415) 595-1111

SAN FRANCISCO

Royal Motor Sales
280 S. Van Ness
(415) 626-2171

SAN JOSE

Smythe European Motors
5080 Stevens Creek Blvd.
(408) 244-0985

SAN MATEO

Burlingame Volvo
825 N. San Mateo Drive
(415) 348-5432

SUNNYVALE

Royal Volvo
805 E. El Camino Real
(408) 245-4684

WALNUT CREEK

Lester G. Lawrence
1639 N. Main Street
(415) 939-3333

WHY THE U.S. GOVERNMENT HAS JUST BECOME ONE OF VOLVO'S BIGGEST CUSTOMERS.

The U.S. government has bought 24 Volvos.

Ultimately, all 24 will become total wrecks.

They'll be slammed into each other in violent collisions. And crashed head-on into other cars at 80 miles per hour.

It's all part of a government crash-testing program that will help establish safety standards for cars of the future. Volvo was selected for this program because preliminary crash-testing showed it had an impressive potential for occupant protection.

We're not surprised. At Volvo, safety has always been an obsession. In fact, Volvo had many safety features as standard equipment years before government regulations required them on cars. Things like seat belts. Padded dashboards. And a safety steering column.

To this day, Volvo still has safety features many cars lack. Child-proof rear door locks. 3-point inertia reel seat belts in the rear as well as front. 4-wheel power disc brakes with dual triangular circuits that give you about 80% of your stopping power even if one circuit fails.

Volvo doesn't build cars with decorative roof panels and tiny opera windows. Because those things restrict visibility. Instead, Volvo gives you 3,830 square inches of tinted glass. And roof pillars strong enough to support seven tons, yet narrow enough to allow you over 90% of your total horizontal field of view.

Volvo also feels the better a car handles and performs, the safer it will be. So you get rack and pinion steering, spring-strut front suspension and a fuel-injected overhead cam engine.

Government testing of Volvos will probably result in safer cars in the future.

But when it comes to safety, there's no time like the present.

Buy a Volvo today.

VOLVO

The car for people who think.

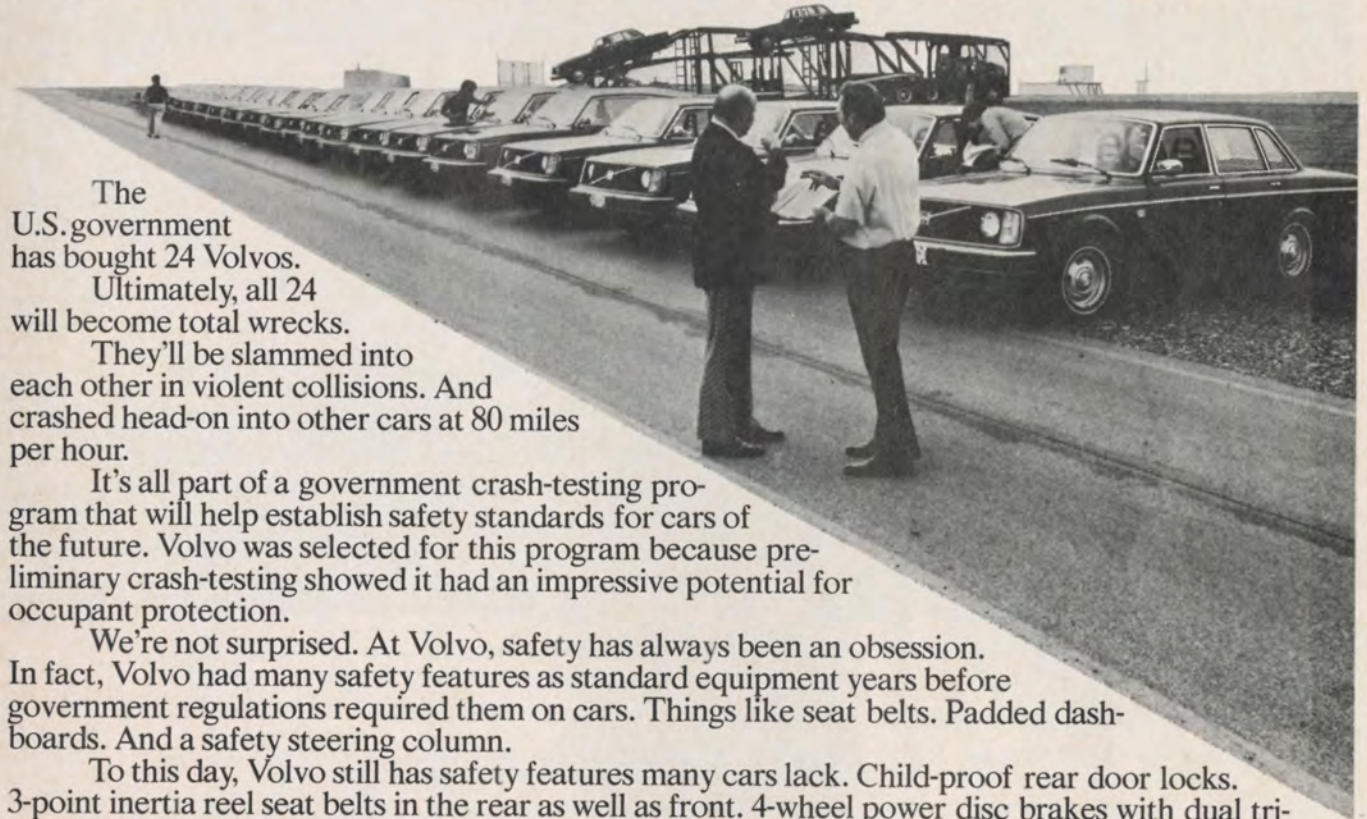

There's a place in San Francisco where out on the town is just outside your door. Where luxurious cruise ships dock at your doorstep. Where you can live a city life of incomparable convenience and uncompromising pleasure. This place is Telegraph Landing. We invite you to come visit these splendidly designed town houses and condominiums in the heart of San Francisco's historic waterfront. Telegraph Landing. A great place to live. A great way to live.

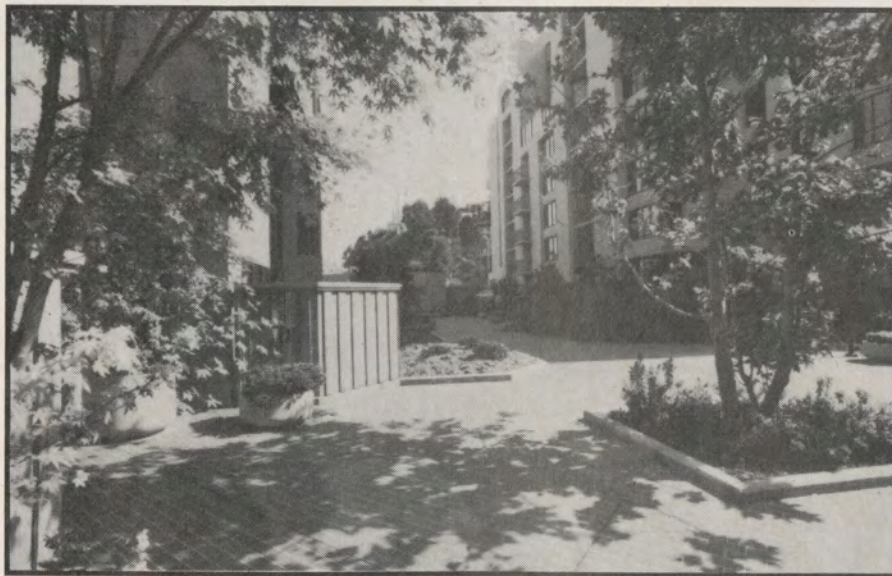

For those determined to enjoy all the pleasures of city life.



Telegraph Landing
 150 Lombard at Sansome, San Francisco 94111
 (415) 788-4488

Still Verismo

continued from p. 20

that illuminate our experience of the repertory's greatest double-bill.

* * *

"Poverty is endemic to Southern Italy, as are erosion, aridity, dysentery, typhoid, unfinished buildings, open sewers, and squalid hotels."

Both operas take place on important

*All quotations made with the permission of the publisher.



festival days—Easter in *Cavalleria* and the Feast of the Assumption in *Pagliacci*—and the villagers ought to be dressed in their best finery. Perhaps because of this we may forget that privation and squalor are the true back-drop for these operas. It is a measure of the standard-of-living that Alfio owns four healthy mules and is respected as a wealthy man. In Gio-

continued on p. 24



John Simmons

THE SOAP OPERA.

Be it an aria from Puccini or sounds from Nashville, any voice will sound bubblier when using John Simmons Showermike.

6 ounces of hard-milled soap-on-a-rope, it's the brightest way to begin anybody's day in the shower.

\$5 Plus tax for the gov'nor . . . and \$1.50 for the postman. Need 3 for a trio??



540 on the Sunny Side of Sutter
San Francisco 94102

For 6,000 years men have been making the harrowing trek to the Badakshan mines north of the mighty Hindu Kush mountains in Afghanistan in search of the mystical blue gemstone Lapis Lazuli.

There this most prized of ancient gemstones lays hidden in the strata of black and white limestone. Here, this utterly enchanting stone is fashioned into two perfectly beautiful necklaces and an intriguing ring.

Just three examples from the Fox's St. Francis Lapis Lazuli Collection.

You can start a Lapis collection of your own with a 16-inch strand of beads for just \$120. Then add the fashion excitement of a 30-



inch strand of Lapis, 14kt. gold and rock crystal beads. Fantastic, and just \$450. Now try a Lapis ring. This one is dazzling with two hand-carved stones of intense blue set in 18kt. gold. \$550. So, plan to drop by soon. You'll

discover that San Francisco's most unique jewelry salon is also San Francisco's most friendly place to shop.

FOX'S
St. Francis / 989-5409
IN THE LOBBY,
ST. FRANCIS HOTEL

Celebrate Hawaii family-style.



United's Hawaii condominium vacations give you the comfort and economy of a beautifully furnished home or apartment in the Islands.

It's your own bit of privacy in paradise. Big bedrooms. Bar. Maid service. A fully equipped kitchen. Maybe a rental car with unlimited mileage parked outside.

You're near the beach, golf, tennis, restaurants, shopping and entertainment. And that beach can be on Oahu, Hawaii, Maui, Molokai or Kauai.

The price for four can be as little as \$13 a night, per person, including tax. Imagine how a family or group of friends can save.

And on the way over and back, you'll enjoy United's Royal Hawaiian Service. Polynesian food, exotic drinks, Hawaiian stewards... all the atmosphere of the Islands.

So be at home in Hawaii; send for your United condominium vacation brochure soon.



United Airlines
P.O. Box 27, Dept. 74b
Glenview, IL 60025

Please send your free Hawaii Privacy in Paradise brochure.

NAME _____

ADDRESS _____

CITY _____

STATE _____ ZIP _____

Our little corner of the world.



UNITED AIRLINES

Still Verismo

continued from p. 23

vanni Verga's original short story, blood gurgles from Turiddu's throat as he worries, not about his amorous liaisons, but about how his penniless mother will survive. We should not let Mascagni's spirited drinking song and chorus (*Viva il vino*) make us forget that these men are drinking foul wine in a musty tavern on a run-down little *piazza*—as must countless frus-

trated, unemployed Southern Italian men.

Verga made his reputation (comparable with Steinbeck's in this country) writing about what he called "*I Vinti*"—the downtrodden. A careful producer of *Cav* and *Pag* will not forget this. An effective staging of these op-

continued on p. 26

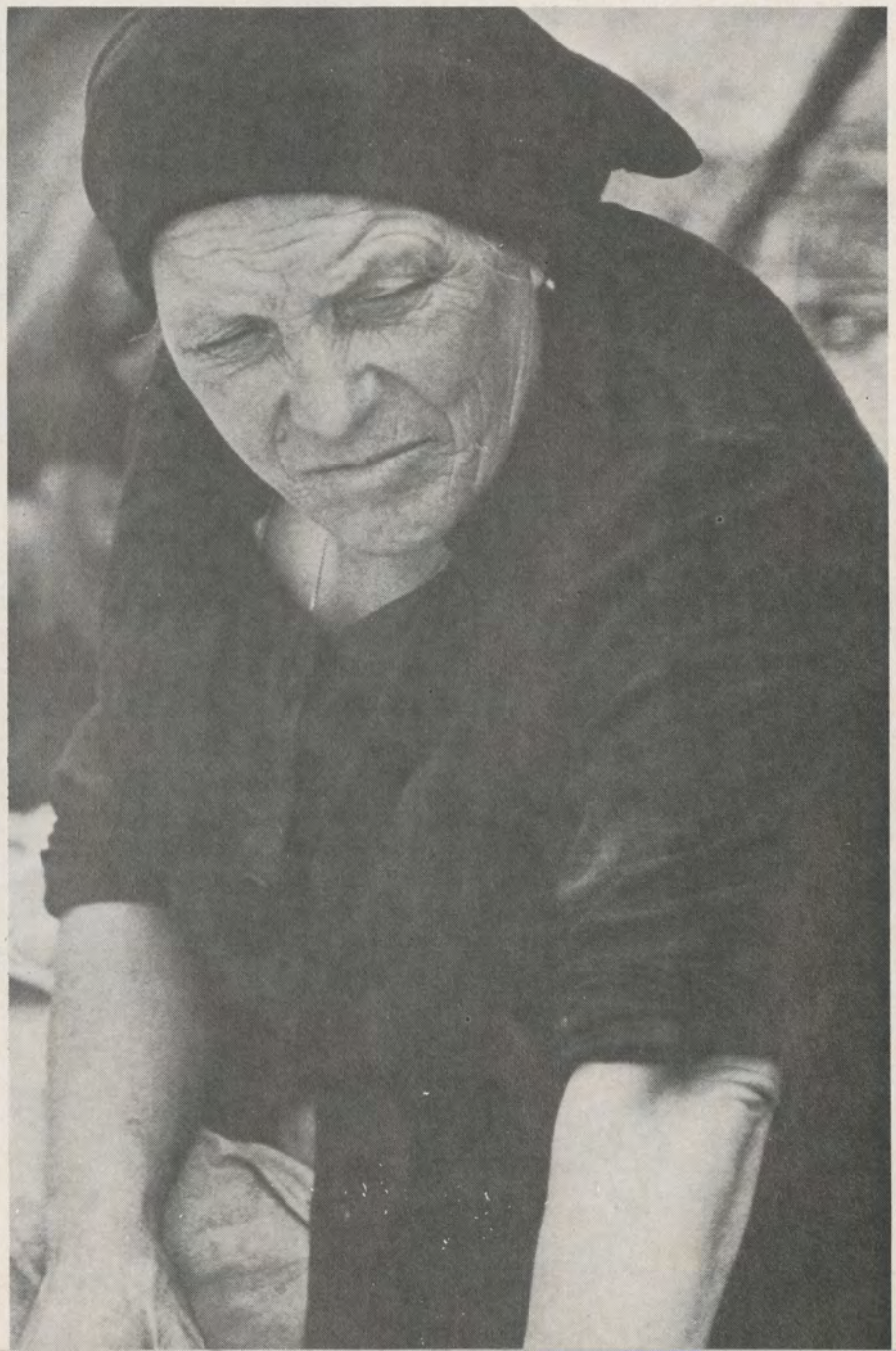



Gateway Cinema

215 Jackson St.
San Francisco, Calif.
GA-1-3353

Wed. thru Tues. Nov. 3 - 9

2 IMMORTAL FRANK CAPRA CLASSICS!
Ronald COLMAN—in—James HILTON'S
"LOST HORIZON"
—also—"DIRIGIBLE"

Wed. thru Tues. Nov. 10 - 16

Fred ASTAIRE & Ginger ROGERS
Irving Berlin's "TOP HAT"
—also—EDDIE CANTOR—in—
Büsbü Berkeley's Art Deco
Musical Extravaganza!
"ROMAN SCANDALS"
—plus—LAUREL & HARDY'S
Academy Award Winning Comedy
"THE MUSIC BOX"

Wed. thru Tues. Nov. 17 - 23

Back in Answer to Many Requests!
NEWLY REDISCOVERED, DELIGHTFUL
ORIGINAL VERSION OF "CABARET"!
Julie HARRIS—Laurence HARVEY
"I AM A CAMERA"—also—
Cary GRANT & Ingrid BERGMAN
"INDISCREET"

Wed. thru Tues. Nov. 24 - 30

COMPLETE ORIGINAL VERSION THAT
TV COULDN'T SHOW WITHOUT CUTS!
Winner of EIGHT Academy Awards!
BEST PICTURE! BEST DIRECTOR!
BEST ACTRESS! LIZA MINNELL!
"CABARET"—also—
Angela LANSBURY—Michael YORK
"SOMETHING FOR EVERYONE"

Richelieu Cinema

1075 Geary St.
San Francisco, Calif.
PR-1-5200

**MONTH LONG
RUDOLF NUREYEV FILM FESTIVAL!**

Wed. thru Tues. Nov. 3 - 9

"I AM A DANCER"—also
Bolshoi Ballet "CINDERELLA"

Wed. thru Tues. Nov. 10 - 16

Rudolf NUREYEV—Margot FONTEYN
"AN EVENING WITH THE ROYAL BALLET"
—also—Claude RAINS—Vivien LEIGH
—in—GEORGE BERNARD SHAW'S
"CAESAR & CLEOPATRA"

Wed. thru Tues. Nov. 17 - 23

Rudolf NUREYEV—Margot FONTEYN
"BALLET OF ROMEO & JULIET"
—also—Franco ZEFFIRELLI
& Lina WERTMULLER'S
"BROTHER SUN, SISTER MOON"

Wed. Thru Tues. Nov. 24 - 30

Rudolf NUREYEV—Robert HELPMANN
"DON QUIXOTE"—also—
Peter O'TOOLE—Sophia LOREN
"MAN OF LA MANCHA"

Wed. thru Tues. Dec. 1 - 7

**DECEMBER IS ALFRED HITCHCOCK
MONTH!**

Ingrid BERGMAN—Gregory PECK
"SPELLBOUND"—also—
Cary GRANT—Joan FONTAINE
"SUSPICION"

TOP QUALITY 35MM PRINTS USED EXCLUSIVELY

Buy a Gateway/Richelieu Membership Discount Card & Save \$1.00
Every Time You Attend Either Theatre Through June 30, 1977



The Los Angeles Philharmonic goes to sea!

Opus XI to the Mediterranean
The Los Angeles Philharmonic
Gala Cruise
May 2-May 21, or
May 2-May 16, 1977

For the first time ever, you will be able to cruise with 110 of the world's finest orchestral musicians — the members of the famed Los Angeles Philharmonic — and their celebrated music director, Zubin Mehta. Also aboard will be guest soloists, who will perform through May 21; The Los Angeles Philharmonic will perform during May 2 - May 16. This is one of what we call our Not-For-Everyone Cruises — because the very best is appreciated only by a very few. And here is the very best of cruising and music combined.

The M.T.S. Danae becomes a floating concert hall as you sail in luxury to Barcelona; Palma de Majorca; Livorno (Florence); Civitavecchia (Rome); Ephesus; Porto Carras; Piraeus (Athens); Mykonos; Heraklion; Taormina. With shore trips to the seats of ancient cultures and three great religions.

Come enjoy the spacious comfort, the fine cuisine and service of a vessel designed to be virtually your own private yacht — plus the glorious music and warm sun, the graceful and historic ports. For complete details, see your travel agent or mail our coupon.

The M.T.S. Danae is of Greek registry.

To: Exprinter International PASF-10/76
500 Fifth Avenue
New York, NY 10036

Please send details on the Opus XI cruise.

Name _____

Address _____

City _____ State _____ Zip _____

My travel agent is _____

Still Verismo

continued from p. 24

eras, for all their towering passions, will leave one with a pervading sense of hopelessness and oppression — a taste of the dregs and the smell of dust. The villagers should be stooped and bent by the cruel task of eking a living from a barren, scorched land. If this pall of misery is well cast, moments like Turiddu's farewell or Nedda's ballatella ("Hui! Hui! Stridono

lassu")—which reflects not merely the desire to escape a poisoned marriage but also from the horror of poverty itself—will be all the more effective.

* * *

"Odd that we insist that 'simple' people, poor people, do not feel deep, continuous emotion. We allow them animal explosions of rage or passion

continued on p. 28



*The Results of the Airline Passengers Association
Biennial Independent Survey of Frequent Fliers:*

American named 'No.1 choice for domestic air travel.'

APA survey results
published March, 1976.
This is the third
consecutive APA survey
to name American
the No. 1 domestic
airline.

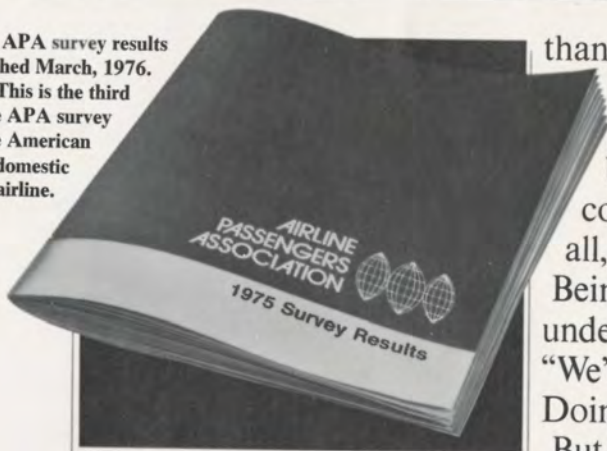

"If you were traveling to any destination in the U.S., and had your choice of any U.S. airline, which airline would you choose—and why?"

The Airline Passengers Association asked that in a survey of frequent fliers—people who averaged more than 35 flights a year.

The results were conclusive: more people chose American

than any other airline.

And the reasons were many: schedules, reliability, comfort, courtesy, convenience—and most of all, service.

Being named number one underscores our right to say, "We're American Airlines. Doing what we do best."

But it also gives us the responsibility to go on proving ourselves, day after day and flight after flight.

**We're
American Airlines.
Doing what we
do best.**

Next flight, we hope
you'll let us prove it
to you.



A THING OF BEAUTY . . . from CRESALIA

Post Street, San Francisco Since 1912

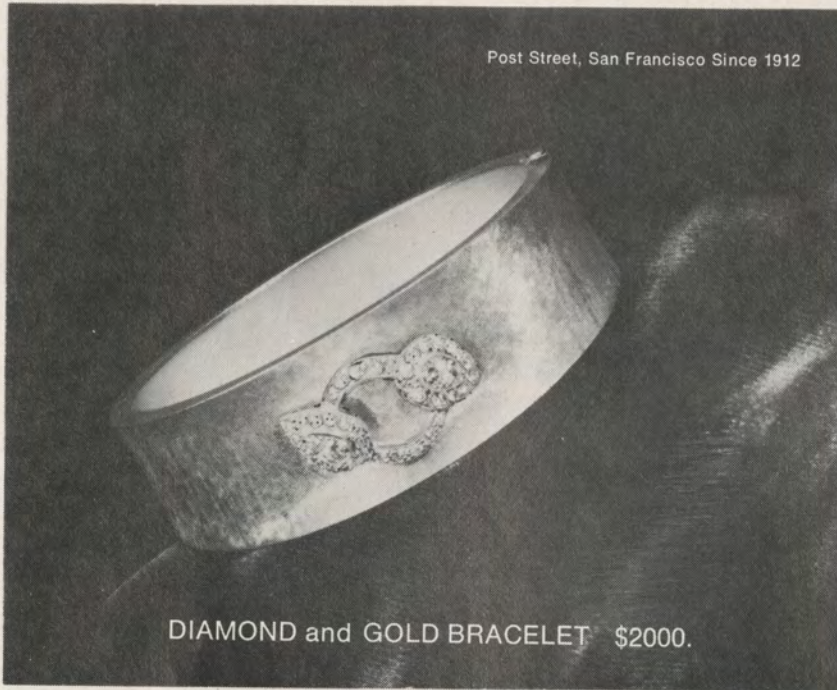

DIAMOND and GOLD BRACELET \$2000.

781-7372

2nd Fl.
278 Post St.
at Union Square

CRESALIA
Niderost & Taber
JEWELERS

2nd Fl.
278 Post St.
at Union Square

Show Topper.

Hugo's is a great place to begin or end an evening on the town. Enjoy the incredible view over a delectable dinner or a soothing night cap. 36 stories above San Francisco. 398-1234.

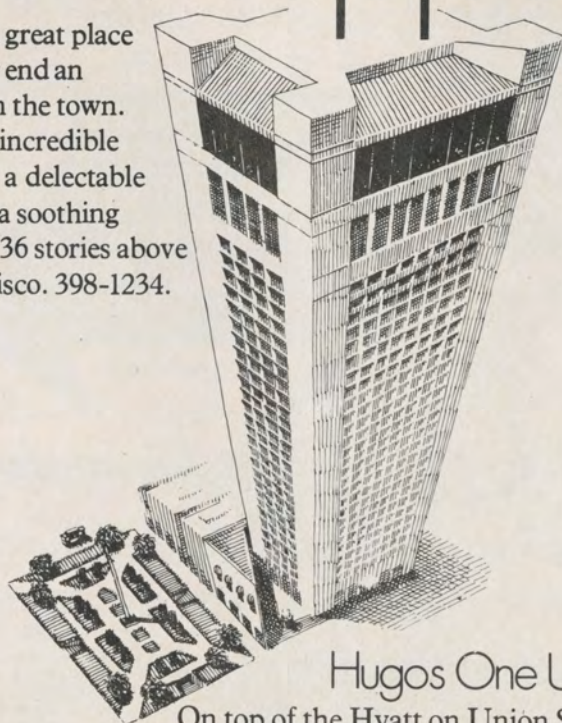

Hugos One Up
On top of the Hyatt on Union Square.

Still Verismo

continued from p. 26

or illogical exuberance and then dismiss them as too insensitive to suffer from the more subtle miseries that we, the princes and princesses of a more intellectual world, must endure."

Cavalleria Rusticana appeared first as a five-page short story in 1880 and as a one-act play in 1884—a vehicle for the Sarah Bernhardt of Italy, Eleonora Duse. Its author was the first Italian writer to take the poor people of the South seriously as people and write about them "from the inside out." He was among the first to realize that they do suffer what Cornelisen calls the more subtle miseries. That the purest, if not strictly speaking the first *verismo* opera should be a setting of a Verga text is one of those fortunate and gratifying coincidences in the history of literature-made-into-opera.

The realist revolution was begun by such men as Stendhal, Scott and Balzac, who focused upon the lower classes—not, as in previous literature and opera, as comic butts (Leporello the great exemplar) but as human, feeling beings. It is no coincidence that Mérimée, whose story was the source for *Carmen* (the single most important precursor of operatic *verismo*, was also a crucial figure in the dawning of literary *verismo*. Indeed, many of Mérimée's short stories, especially "Mateo Falcone," could well be titled "Chevalerie Rustique."

Before.



Begin your evening by dining in the gracious elegance of Victor's. High above the city. On Union Square. 32nd floor of The St. Francis.*

Spectacular view. Superb cuisine. And a wine list for the connoisseur.

The perfect overture to a memorable night.

Dinner from 6 p.m., including Sunday.
Reservations: 956-7777.

Victor's

atop The St. Francis on Union Square

After.



Top off your evening by stopping in for a nightcap at The Penthouse. On Union Square. 32nd floor of The St. Francis.

Live music. Lively dancing. Bountiful drinks. And an unmatched view of the city and glistening lights across the bay.

The grand finale to a memorable night.

No cover. No minimum.

Reservations: 397-7000.

THE PENTHOUSE

atop The St. Francis on Union Square

Gone, with operas like *Cavalleria* and *Pagliacci*, were mythical figures, magical romance characters, aristocrats, or sophisticates. In their place we have more elemental characters like Don Jose, Canio, and Santuzza. These figures prove that "simple" people do indeed feel deep, continuous emotion. And it is upon elemental emotions that opera thrives best.

* * *

"[A husband speaking of his wife] She is a good woman, and I know that she is faithful. The other husbands—not one of them is sure. It brings on a kind of madness."

Not love but jealousy—the green-eyed monster—dominates both operas; both focus upon the "madness" that it brings on—a madness that is always perilously close to the surface of marital life in Southern Italy, where the cuckold's horn are still the most hideous shaming objects.

The plot of *Cavalleria* is typical of the loveless amorous gamesmanship that results when the maintenance of "honor" (or its appearance) becomes more important than sincerity or affection. Pride, not love, motivates all the characters. Turiddu never once admits he loves either Lola or Santuzza (he says only that he has promised to lead Santuzza "to the altar"). We know from Verga's story that he first courted

continued on p. 63

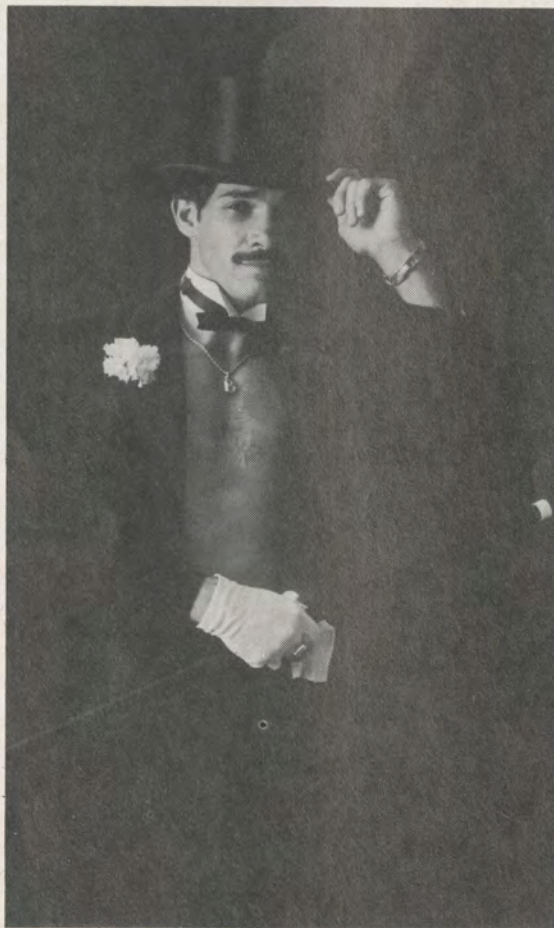

YIANNI!
all over your
body...

in gold
& in sterling.

OFF UNION SQUARE -
235 POWELL STREET - SAN FRANCISCO, CAL. 94102
AT GHIRARDELLI SQUARE -
900 NORTH POINT - SAN FRANCISCO, CAL. 94109



This man has a successful business, a secure future, and over \$300,000 in earning assets. Why would he need a Living Trust?



For the same reason you do.

It's one of the ironies of life that the last person who would appear to need a Living Trust, needs it most. The man above, for example, or you. Because the more successful you are at managing your business affairs, the less time you necessarily have to devote to the day-to-day management of your personal finances. And that's where a Living Trust comes in.

Unlike ordinary trusts set aside for the future, a Living Trust

is in effect here and now. It's designed to help you benefit in the present: by providing expert management of your investments, real estate, securities, taxes—all aspects of your personal finances that need looking after, while you're busy looking after business. A team of specialists is assigned to your account for watchful guidance and fast, knowledgeable decision-making. They can balance your books, help you save on income

taxes and professional fees, and suggest ways to improve your estate while you're still around to enjoy it.

The more successful you are, the more reason you have to take advantage of a Living Trust. Stop in and talk with one of our Bank of America Trust Officers. He'll convince you, if this hasn't. Depend on us. More Californians do.

BANK OF AMERICA 
Trust Department

Cruise the South Seas on ships as friendly and warm as Polynesia.



Jan. 2, Feb. 8, Mar. 13.*

No other vacation can match the enchantment and splendor of a South Seas cruise with the friendly Americans, the SS Mariposa or SS Monterey.

You'll cruise 15,000 miles of peaceful Pacific. Visit ports of call that read from pages of Captain Cook's log. And best of all, you'll enjoy a sea life made famous by sister ships over 90 years ago. One that today has become the hallmark of luxury cruising in the Pacific.

The SS Mariposa and SS Monterey are renowned for their friendly hometown hospitality and Aloha Spirit. Plus the kind of cuisine, service, accommodations and entertainment Americans love best.

Registered in the United States, these proud ships are small enough to

offer an intimate atmosphere, yet big enough to have everything an all first-class ship should have.

If you join us in California, the cruise is 43 days round-trip. (Dates shown are from San Francisco, with departures a day later from Los Angeles.) Or you can board in Honolulu for a 31-day round-trip cruise with sailings six days later than from San Francisco.

***49-day cruise March 13.**

We also have a special, longer cruise with an alternate 14-port itinerary that includes Tasmania and both the South and North Islands of New Zealand. It's 49 days round-trip from California, or

38 days from Honolulu.

Whichever you choose, now is the time to make that South Seas dream come true. See your travel agent now or send us the coupon for full information.

MAP SHOWS 43 DAY ITINERARY

LOS ANGELES

Cruise Consultant, Pacific Far East Line,
Pier 35, San Francisco, CA. 94133.
Please send me your brochure on:

South Seas Cruises Hawaii Cruises

Name _____
Address _____
City _____
State _____ Zip _____
Travel Agent _____

TM-1611-1076

Pacific Far East Line
SS Mariposa SS Monterey The friendly Americans



Oh, the disadvantages of our long cigarette.

Benson & Hedges 100's

17 mg. "tar," 1.1 mg. nicotine,
av. per cigarette—hard pack, by FTC Method;
18 mg. "tar," 1.1 mg. nicotine,
av. per cigarette—soft pack, FTC Report, Apr. '76.

Warning: The Surgeon General Has Determined
That Cigarette Smoking Is Dangerous to Your Health.



As Kurt Herbert Adler wrote in his introduction to this year's brochure, "San Francisco Opera takes pride in celebrating the Twin Bicentennial of the City of San Francisco and the nation by presenting a wide-ranging repertoire which strongly emphasizes artistic accomplishments of the 20th century." Each year, our fall season seems to surpass in excellence those which have gone before and 1976, our 54th consecutive year, will, I am confident, reach new heights. We open with the San Francisco premiere of Massenet's "Thais"; the title role will be sung by the glamorous and exciting Beverly Sills.

Our contribution to the Bicentennial will be the world premiere of "Angle of Repose". This opera is based on Wallace Stegner's Pulitzer Prize winning novel and was commissioned by the San Francisco Opera Association. Composer Andrew Imbrie and librettist Oakley Hall have adapted the novel to grand opera which will be sung by an all-American cast. Nine other operas, some old favorites, some of modern vintage, complete this well-balanced season. Our brilliant general director, Maestro Adler, with his splendid staff and well organized company, will again demonstrate that San Francisco Opera continues to be included among the few great opera companies in the world. Advance ticket sales indicate that the community recognizes this and that we will continue the nearly 100% capacity attendance which we have enjoyed in recent years.

In addition to "Thais" and "Angle of Repose", we will have new productions of four operas. The wear and tear on sets and costumes is fantastic and it is also exciting to see old favorites in new clothes. However, new productions are terribly expensive and we must depend on substantial gifts by interested donors to make them possible. We are indebted to Cyril Magnin, a long-time friend of San Francisco Opera, for a generous gift making possible the new "Thais". "Angle of Repose" has been financed

by substantial gifts from San Francisco Foundation, City and County of San Francisco, National Endowment for the Arts, as well as contributions by a number of arts patrons. For part of the new production of "La Forza del Destino" we are grateful to a number of arts patrons and the William H. Noble Estate. "Die Frau ohne Schatten" was made possible by the generosity of arts patron Cynthia Wood. Our vice president and treasurer, James D. Robertson, for the sixth consecutive year, has financed part of a new production—this year "Cavalleria Rusticana" and "I Pagliacci."

To all of these patrons go our special thanks.

Opera in San Francisco is not just the International Fall season which we are now enjoying, but is a year around program, all under the general direction of Mr. Adler and his staff. These activities include Spring Opera Theater, Western Opera Theater, Merola Opera Program, Brown Bag Opera and San Francisco Opera Auditions. Our total program is unique; no other opera company in the country can boast of such scope.

Opera is probably the most expensive performing art form. This can be readily understood when one considers the hundreds of people necessary to stage a production of the quality for which we are renowned. Our costs for 1976 are estimated at \$5,700,000. Ticket revenues cover just over 60% of these costs, a ratio which is probably higher than any major opera company in the world. To put this in perspective, if we were to depend solely on ticket revenues to cover our costs, our prices would have to range from about \$11.00 to \$41.50 per seat instead of our actual range of \$6.00 to \$25.00. You may have read recently that the portion of annual costs of the Paris Opera which are subsidized by the French Government have reached 17 million dollars, a figure almost three times our total costs. And yet, on a visit there a few months ago, my ticket cost me the equivalent of \$30.00!

How have we raised the remaining 40% of our costs? From generous patrons who finance new productions, from guarantors, grants from local and federal governments, income from our endowment funds, donations from the Opera Guild, and from contributions by corporations, foundations and individuals to our annual Operating Fund campaign. But costs continue to rise because of inflation and we must in-

crease the number of contributors significantly if we are to avoid substantial deficits. Thousands of loyal opera lovers help each year, but thousands more are needed. If you are not presently a contributor to our annual fund drive, won't you please join now? Your tax deductible contributions should be sent to San Francisco Opera Association, War Memorial Opera House, San Francisco, 94102. Opera's future depends on you. Don't let us become a candidate for the list of endangered species.

We continue to be grateful for the financial support from various organizations, without whose help we would find it almost impossible to continue—National Endowment for the Arts, National Opera Institute, Mayor George Moscone, Chief Administrative Officer Thomas J. Mellon, the City and County of San Francisco, and the War Memorial Board of Trustees. We are also indebted to Opera ACTION which continues to render all kinds of help to San Francisco Opera, not only reducing our costs but spreading the word of opera throughout our community.

For many years, each opera has been broadcast once over KKHJ AM/FM in San Francisco and KFAC AM/FM in Los Angeles. This year, broadcasts will be extended to audiences in Sacramento, Fresno, San Diego, Portland and Seattle. These broadcasts are made possible by grants from Standard Oil Company of California and the L. J. and Mary C. Skaggs Foundation of Oakland, California, for which we are most grateful. The quality of the broadcasts is exceptional and you owe it to yourself to listen.

San Francisco Opera Guild finances five student matinees of one of the operas in the series. This year, thousands of young people will enjoy "The Barber of Seville." For many this will be their first exposure to grand opera. From their enthusiastic response over the years, opera is assured of audiences in the future.

Each year, San Francisco Opera brings the joys of this wonderful performing art alive to tens of thousands of opera lovers and, through the magic of radio, to countless others. Our goal is always to bring to you performances of the highest quality and, with your help, we will continue to achieve that goal.

WALTER M. BAIRD
President and Chief Executive Officer

PANACENTERS, INC.

the total concept in audio and video systems cordially invites you to attend their **GRAND OPENING CELEBRATION** from October 6-9 [Daily 10-7 Sat. 10-4] at 633 Battery St. One Jackson Place Arcade

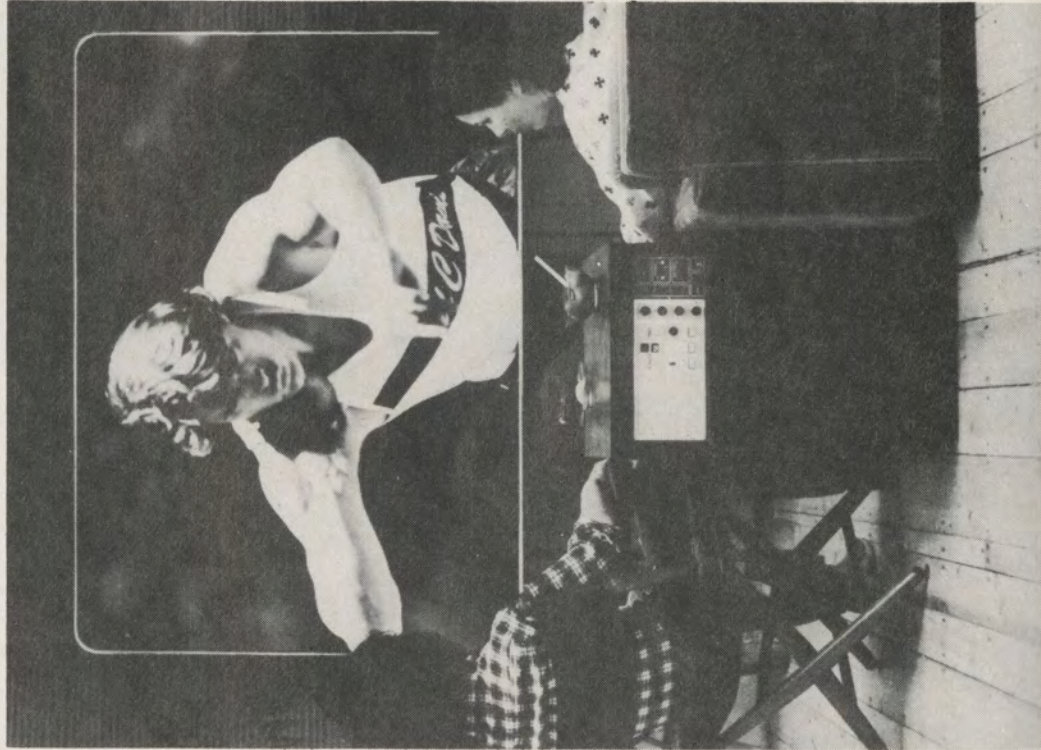

- Introducing Advent VideoBeam® Color Television Projection System Model 750—The theater in your home.

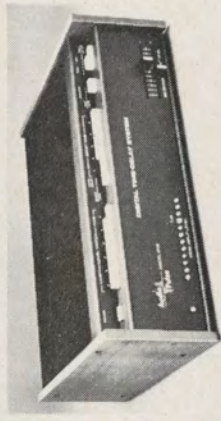

- Introducing Audio-Pulse: The most extraordinary advance in Stereo Sound which adds the third dimension.

- The ultimate in home entertainment technology is at Panacenters.

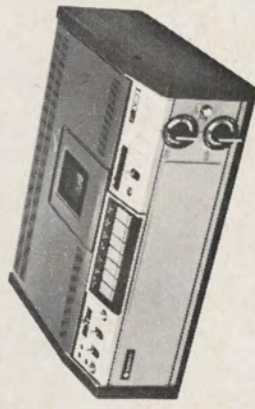

- Introducing The Sanyo V-Cord II home video cassette recording system with **two hour** record/play-back. Record while you're out. Record one program and watch another.

- INTRODUCING THE MEDIA ROOM
- INTRODUCING THE ULTIMATE SOUND ROOM—A NEW WAY TO BUY YOUR SYSTEM

989-2889

Officers

R. Gwin Follis
Chairman of the Board

Walter M. Baird
President and Chief Executive Officer

Richard K. Miller
Vice President

James D. Robertson†
Vice President and Treasurer

Emmett G. Solomon
Vice President—Development

Robert C. Harris
Secretary

Board of Directors

Mrs. Angelina G. Alioto
Ernest C. Arbuckle
Walter M. Baird*
Philip S. Boone
Arthur Merrill Brown, Jr.
John M. Bryan
Edward W. Carter
John B. Cella, II
Mrs. Marquis Childs
A. W. Clausen
Dr. Alexander Cross
Mrs. Joseph D. Cuneo
Reid W. Dennis
Mrs. Dewey Donnell
Rudolph J. Drews
Mrs. Lennart G. Erickson
Mrs. Wayne H. Fisher
R. Gwin Follis*
Alfred Fromm
Robert Gerdes
Mrs. Gordon P. Getty
William W. Godward
A. Adrian Gruhn
Prentis Cobb Hale* **
Richard C. Ham

Mrs. Richard C. Ham
Mrs. William H. Hamm, III
Robert C. Harris*
Reuben W. Hills, III
Jay Holmes
Mrs. Thomas Carr Howe
Fred G. Hudson, M. D.
Jerome W. Hull
Jaquelin H. Hume
Philip M. Jelley
Edgar F. Kaiser
Mrs. Frederick O. Koenig
Roger D. Lapham, Jr.
Robert C. Leefeldt
Mrs. Rudolph A. Light
George S. Livermore
Mrs. Carl Livingston
Richard B. Madden
Cyril Magnin
John R. Metcalf
Lawrence V. Metcalf
Otto E. Meyer
Otto N. Miller
Richard K. Miller*
Mrs. Louis A. Petri

Mrs. John P. Renshaw*
Mrs. Robert L. Richards
James D. Robertson*
Arthur Rock
Mrs. William P. Roth
Mrs. Madeleine Haas Russell
James H. Schwabcher, Jr.
Mrs. Louis Sloss
Emmett G. Solomon
Mrs. Muriel McKeivitt Sonné
Mrs. Richard L. Swig
Henry F. Trione
Mrs. Nion R. Tucker
Mrs. Bradford H. Walker
Brooks Walker, Jr.
Mrs. Richard C. Walker
Mrs. Edmond C. Ward
Whitney Warren
Mrs. Paul L. Wattis
Cynthia Wood
Mrs. Georgia M. Worthington
Harold L. Zellerbach
Peter Zuber

*Member, Executive Committee
**Trustee, National Opera Institute
†Member, National Council on the Arts

Administration

Kurt Herbert Adler*†§
General Director

Ruth Allison Felt
Company Administrator

Matthew Farruggio
Production Coordinator

Michael L. Sack
Business Administrator

Herbert Scholder
Director of Public Relations

John M. Ludwig**‡
Artistic Administrator

John Priest
Technical Director

D. M. Azinoff
Financial Consultant

Margaret K. Norton
Ticket Sales Manager

W. Anthony Waters
Musical Assistant to the General Director

Nancy McDermott
Director of Development

*Vice President, OPERA America
†Trustee, National Opera Institute
§Member, International Association of Opera Directors
**Consultant, National Endowment for the Arts
‡Director, OPERA America

Administrative Staff

Office of the General Director

Kathleen Allen, Sally D. Culley, Dita H. Pepin, Laila Volpe, Monyene Zaki

Box Office

Gerald Fitzgerald
Treasurer

William Mathews
Richard Teska
Assistant Treasurers

Eleanor Dodge, Richard Sparks,
Norman Wong

Business Office

John Olsen
Chief Accountant

Sidney D. Waxman
Budget Coordinator

Els J. Stolk, Gordon Taylor

Development Office

Virginia Westover
Assistant Director of Development

Alie Zeidler

Public Relations

Caroline C. Crawford
Press Representative

Paul Chaplin
Staff Writer

Anne L. Mays
Jesse Hollis

Technical Office

Jane Ayres

Switchboard

Olivia Burton, Donna Kolb

Administrative Interns

Ruth Goldstein *Management in the Arts Program, University of California, Los Angeles*
Renee Roatcap *Brown Bag Opera Coordinator, Comprehensive Employment Training Act (C.E.T.A.)*

San Francisco Opera is a member of OPERA America

Mint Prints

If you've made the San Francisco gallery circuit and are still searching for a top quality *original* graphic, you've bypassed Pasquale Iannetti. At 560 Sutter, a wide selection of works ranging from the 16c. through the present are exhibited; a sampling: DURER, REMBRANDT, GOYA, LAUTREC, PICASSO, MATISSE, MIRO, CHAGALL, BRAQUE, CALDER, GAUGUIN, ERNST & MORE.

PASQUALE IANNETTI
560 Sutter Suite 201 S.F. 433-2771
Tues.-Sat. 10-5:30 Mon. by appt.

Oldies But Goodies

Whether you're into Art Deco or French Provincial, the San Francisco Antique Show will more than satisfy your aesthetic yearnings. Collectibles include silver, furniture, cut glass, needlework, textiles, decorative items and MORE. There's something for everyone—THE potpourri of antiques.

SAN FRANCISCO ANTIQUE SHOW
San Francisco Exhibit Center/
Merchandise Mart Complex
10th & Market Hrs. 12-9 pm, Sun. 12-6 pm
October 21-24 Admission \$2 with Ad \$1.75

Fly By Sight



Now that fall's arrived, off-season travel means leisurely touring *sans* masses of hasty tourists; providing you've the time and money. Fortunately, Golden Gate Geographic Society has come to the rescue of us arm-chair travellers—with a series of personally narrated color travel films. The October tour covers that wonderful Aegean paradise Greece. Narrated by Sherilyn and Matthew Mentés, the films will be presented at:

SANTA ROSA HIGH AUDITORIUM—10/26, SF VETERANS' AUDITORIUM—10/31, OAKLAND AUDITORIUM—11/6, COLLEGE OF MARIN—11/7. Series tickets are still available (6 programs/\$15).



GG GEOGRAPHIC SOCIETY

Mail orders: 851 Burlway Rd., Suite 627, Burlingame 94010
BOX OFFICES: MACY'S, EMPORIUM, CAPWELL'S, SF DOWNTOWN CENTER, THRAM'S (OAKLAND), COLLEGE OF MARIN (WEEKDAYS). In Santa Rosa, EMPORIUM & COOPER'S. Also available at all theatre box offices. Open 1 hour before program.
INFORMATION 347-3636 (Mon.-Fri.)

Red Ryder Returns

The sold-out houses and critical acclaim for "When you comin' back Red Ryder?" has given the impetus for the local community production to turn professional—the first time this has happened in San Francisco in many a year. This change in production will be marked by a move from the Eureka Theatre, where it premiered locally, to the Little Fox Theatre for an open-ended run. This award-winning study in psychological terrorism won Mark Medoff the Obie Award for Distinguished Playwriting in 1973-4 in its off-Broadway New York premiere. Matthew Locricchio, who performed at the Little Fox for 2 years in "One Flew Over the Cuckoo's Nest," is the producer.

WHEN YOU ... RYDER?
LITTLE FOX THEATRE
533 Pacific Ave., SF
434-4738
Tickets are available at all major ticket agencies.



A Rose Is a Rose

Gertrude Stein knew the essence of a rose. Margie Belrose deals with the essence of theatrical arts, in all aspects. Dance includes ballet, jazz, tap, flamenco, belly dance, South Indian & Tahitian! Also — drama lessons, music, mime and comedy workshop. For you Renaissance artists—try them all!

THE BELROSE STUDIO THEATRE
1415 Fifth Ave.
San Rafael
454-6422

Eat Your Cake Too

The French do it—and so can you. If you mess up your mousses or your soufflés suffer, Tante Marie can teach you the secrets of French cooking. Classes are small (5-6 people) so all can participate in preparing the 3 or 4 course meal. And best of all — with wine, flowers and whetted appetites — the class dines on its efforts.

TANTE MARIE COOKING SCHOOL
1207 Leavenworth St. San Francisco
\$72.00/6 lessons 771-8667

Hot To Trot

Bobbed hair and spats probably won't make a big comeback but the tea dances of yesteryear are returning! This ancient and once-sacred rite will be revived October 1 at the Hyatt Regency with Al White's 15 piece orchestra playing big band tunes. Dances will be held every Friday in October. Admission free.



HYATT REGENCY—ATRIUM LOBBY
4:30-7:30 Fridays
5 Embarcadero Ctr.

The Company

<i>Conductors</i>	Kurt Herbert Adler, Karl Böhm*, John Mauceri*, Paolo Peloso, John Pritchard, Kenneth Schermerhorn, Otmar Suitner, Silvio Varviso, Christoph von Dohnanyi
<i>Conductors—Student Matinees</i>	Plácido Domingo*, Thomas Fulton*
<i>Chorus Director</i>	Robert Jones
<i>Assisted by</i>	Dennis Giauque
<i>Boys Chorus Director</i>	William Ballard
<i>Musical Supervisor</i>	Otto Guth
<i>Assistant for Artists</i>	Philip Eisenberg
<i>Musical Staff</i>	Randall Bare, Joseph De Rugeriis*, Philip Eisenberg, Thomas Fulton, Warren Jones*, Ernest Frederic Knell*, Allan Lewis, Terry Lusk, Louis Salemno*
<i>Language and Diction Coaches</i>	Elena Servi Burgess* (Italian), Reinhard Karl Hennig* (German), Christiane Tsouo* (French), Ann Lawder* (English), Deborah Sussel* (English)
<i>Stage Directors</i>	Tito Capobianco, Sir Geraint Evans, Alberto Fassini*, Matthew Farruggio, Gerald Freedman*, Ghita Hager, Nikolaus Lehnhoff, Jean Louis Martinoty**, Jean Pierre Ponnelle, David Pountney*, Andreas Prohaska**
<i>Assistant Stage Directors</i>	Richard Abrams*, Ralph Clifford, Matthew Farruggio, Pamela E. McRae, Jean Louis Martinoty**
<i>Stage Managers</i>	Ralph Clifford, Matthew Farruggio, Pamela E. McRae, Robert Ripps*
<i>Production Assistants</i>	Julie Bellisle*, Michele LeMeteyer
<i>Production Apprentice</i>	Dominique Carron
<i>Productions Designed by</i>	Leni Bauer-Ecsy, Jean Pierre Ponnelle, Pierluigi Samaritani*, Douglas W. Schmidt*, Alfred Siercke, Wolfram Skalicki, Carl Toms, Jörg Zimmermann**
<i>Choreographers</i>	Louis Falco*, Ronn Guidi*, John McFall*
<i>Costume Designer</i>	Lawrence Casey*
<i>Lighting Designer and Director</i>	Thomas Munn*
<i>Assistant to the Lighting Director</i>	Sara Linnie Slocum
<i>Sound Design</i>	Peter V. C. Quaintance
<i>Assistant to the Technical Director</i>	Larry Klein
<i>Technical Assistant</i>	Rodney Gordon†
<i>Costume Shop</i>	Walter Mahoney
<i>Costume Supervision</i>	Lawrence Casey*
<i>Wardrobe Department</i>	Craig Hampton, Patricia Bibbins
<i>Wig and Makeup Department</i>	Richard Stead, Paul Alba, Judith Disbrow, Karen Bradley, Rex Rogers
<i>Rehearsal Department</i>	Judith O'Dell, Richard Johnson*, Susan Koscis**
<i>Super Department</i>	Thomas E. Curran, III
<i>Scenic Construction</i>	Pierre Cayard
<i>Scenic Artist</i>	Norman Rizzi
<i>Master Carpenter</i>	Michael Kane
<i>Master Electrician</i>	George Pantages
<i>Master of Properties</i>	Ivan J. Van Perre
<i>Broadcast Coordinator</i>	Marilyn Mercur
<i>Official Photographers</i>	Greg Peterson, Ron Scherl
	Technical Staff for the War Memorial Opera House
<i>Master Carpenter</i>	Michael Willcox
<i>Master Electrician</i>	Jack Philpot
<i>Master of Properties</i>	Perrie Dodson

*San Francisco Opera debut **American opera debut †National Opera Institute Apprentice

The Knabe is the official piano of San Francisco Opera

The 1976 San Francisco Opera season is supported by a much-appreciated grant from the National Endowment for the Arts in Washington, D.C., a Federal Agency, and by a generous grant from the San Francisco Hotel Tax Fund.



919 Grant Avenue
San Francisco 982-4440



The
Gourmet Room
of Chinese Cuisine



THE SAN FRANCISCO SCHOOL



A Montessori environment

An environment fostering social and emotional growth, with personalized attention to basic skills and a creative program of music, movement and drama. Elementary school for ages 6-12. Pre-school for ages 3-6. Nutritional lunches. Extended day care. Exceptional indoor/outdoor setting. A non-profit organization.

**300 Gaven Street
for brochure or
to arrange a visit, call 239-5065**

Artists

Regine Crespin
Claudia Cummings
Faith Esham*
Edna Garabedian
Susan Gorenuc*
Shirley Lee Harned*
Heather Harper
Ruth Hesse*
Nina Hinson
Gwendolyn Jones

Claes H. Ahnsjö**
Lorenzo Alvary
Giacomo Aragall
Walter Berry*
Garbis Boyagian**
John Brecknock*
Renato Bruson
Samuel Byrd*
Renato Capecci
Paul Crook*
John Davies
Placido Domingo
Dale Duesing**
John Duykers
Brent Ellis*
Geraint Evans
Joseph Frank

CHORUS

Women
Janice Aaland
Peggy Ahrens
Kathy Anderson
Candida Arias-Duazo
Doris Baltzo
Roberta Bowman
Norma Bruzzone
Louise Corsale
Patricia Diggs
Beverly Finn
Lisa Louise Hill
Cecilia MacLaren
Tamaki McCracken
Sharon McKibbin
Elaine Messer
Irene Moreci
Penelope Rains
Anna Marie Riesgo
Ramona Spiropoulos
Rose Parker
Bonnie Jean Shapiro

EXTRA CHORUS

Women
Elizabeth Anker
Anne Buelteman
Suzanne Compton
Cynthia Cook
Judith F. Hansen
Margaret Hamilton

BALLET

Women
Margaret DeWitt
Jean Harriss
Wendy Holt
Sherri Parks
Angie Smit
Maria Angela Villa

Raina Kabaivanska
Roberta Knie*
Susanne Marsee*
Janis Martin
Linn Maxwell*
Sheila Nadler
Donna Petersen
Linda Roark
Noelle Rogers*
Leonie Rysanek

Paul Geiger*
Peter Glossop
Clifford Grant
Hakan Hagegard**
Colin Harvey
Joshua Hecht
James Hoback*
Robert Ilosfalvy
Wassili Janulako
James Johnson*
Matti Kastu**
Kolos Kovats**
William Lewis
Juan Lloveras
Chester Ludgin
Alexander Malta**
Raymond Manton

Claudia Siefer
Lola Lazzari Simi
Linda Millerd Smeage
Claudine Spindt
Alma Wells
Sally Winnington
Arlene Woodburn
Garifalia Zeissig

Men
Winther Andersen
Daniel Becker
Robert Bjoernfeldt
David M. Cherveney
Thomas Clark
Robert Clyde
Neil Cooper
Robert Delany
John Del Carlo
John L. Glenister
Ross Halper
Kenneth Hybloom

Judith Harris
Gloria Holmby
Jean Ostrander
Patricia Schuman

Men
Gennadi Badasov

Men
Ric "E" Abel
Isom Buenavista
Jeffrey Judson
Randall Krivonic
Jeffrey Smith
Sulpicio Wagner

Ursula Schroeder-Feinen*
Nancy Shade*
Sharon Sherrard*
Anja Silja
Beverly Sills
Pamela South
Anna Tomowa-Sintow
Tatiana Troyanos
Frederica Von Stade

Sherrill Milnes
Barry Morell
Paul Plishka*
Bruno Prevedi*
Neil Rosenshein*
Hans Sotin*
Peter Strummer
Giorgio Tozzi
Domenico Trimarchi*
Wayne Turnage*
Jon Vickers
Ingvar Wixell

*San Francisco Opera debut
**American opera debut

Gerald Johnson
Robert Klang
Conrad Knipfel
Eugene Lawrence
Kenneth MacLaren
Kenneth Malucelli
Jim Meyer
Thomas Miller
Kent Nagano
Eugene Naham
Charles Pascoe
Kenneth Rafanan
Thomas Reed
Robert Romanovsky
John Segale
Francis Szymkun
James Tarantino
D. Livingstone Tigner
William Chastaine
Tredway
John K. Walters
R. Lee Woodriff

Michael Bloch
Dale Emde
Thomas Hart
Matthew Miksak
Karl Saarni
Lorenz Schultz
James Tipton

Richard Browne
Ballet Captain

Orchestra

1ST VIOLIN

Jacob Krachmalnick
Concertmaster
William E. Pynchon
Ferdinand M. Claudio
Bruce Freifeld
Silvio Claudio
Ezequiel Amador
Mafalda Guaraldi
George Nagata
Ernest Michaelian
Jeanne Marvin
Michael Sand
Celia Rosenberger

2ND VIOLIN

Felix Khuner *Principal*
Herbert Holtman
Virginia Roden
Barbara Riccardi
Robert Galbraith
Gail Schwarzbart
Carol Winters
Eva Karasik
William Rusconi

VIOLA

Rolf Persinger *Principal*
Detlev Olshausen
Lucien Mitchell
Tom Elliott
Kenneth Harrison
Jonna Hervig
Ellen Smith

CELLO

David Kadarach *Principal*
Rolf Storseth
Judiyaba
Sally Kell
Tadeusz Kadzielawa
Helen Stross

BASS

Michael Burr *Principal*
S. Charles Siani
Carl H. Modell
Donald Prell
Philip Karp

FLUTE

Walter Subke *Principal*
Lloyd Gowen
Gary Gray

PICCOLO

Lloyd Gowen
Gary Gray

OBOE

James Matheson *Principal*
Raymond Duste
Deborah Henry

ENGLISH HORN

Raymond Duste

CLARINET

Philip Fath *Principal*
Donald Carroll
David Breeden

BASS CLARINET

Donald Carroll

BASSOON

Walter Green *Principal*
Jerry Dagg
Robin Elliott

CONTRA BASSOON

Robin Elliott

FRENCH HORN

Arthur D. Krehbiel *Principal*
David Sprung *Principal*
James Callahan
Jeremy Merrill
Paul McNutt

TRUMPET

Donald Reinberg *Principal*
Edward Haug
Chris Bogios

TROMBONE

Ned Meredith *Principal*
Mark Lawrence
John Bischof

TUBA

Floyd Cooley

TIMPANI

Elayne Jones

PERCUSSION

Lloyd Davis
Peggy C. Lucchesi

HARP

Anne Adams *Principal*
Marcella De Cray

PERSONNEL MANAGER

Thomas B. Heimberg

LIBRARIAN

Lauré Campbell

BOYS CHORUS

William Ballard
Music Director
Donald E. Osborne
Assistant Music Director
Joellen Piskitel
Accompanist
James Baker
Eric Brudos
Jon Cockerline
Laramie Crocker
John Doxey
James Dreer

George Fernandez
Douglas Fields
Scott Flemming
Brian Gordon
Ben Harrison
Steven Heffelfinger
Ethan Kaplan
Martin Kovach
Martin LaPlaca
Mark Loudon
Stephen Myers
Christopher Nomura

Andrew Podell
Peter Reilly
Marco Remedios
Stephen Rumph
Jeffrey Silver
John Smalley
Dan Tadmor
Clement Ulrichs
James Urquhart
Peter Vizcaino
Bradley White
Douglas Wing

David Stephen



The look
for the
discerning
Gentleman

117 POST
San Francisco
391-7710



**Designer
Eyewear**

**for the style conscious
man or woman...**

Pierre Cardin • Givenchy
Pucci • Christian Dior
Nina Ricci • Rodenstock

specs

Fine spectacle makers since 1922
177 Maiden Lane 986-6589
Just off Union Square

Thursday
November 11th, 1976
8:30
Civic Auditorium

San Francisco Opera Guild
& Geysler Peak Winery
a subsidiary of
the Jos. Schlitz Brewing Company
present

FOL DE ROLO



wine, women, & song

R.S.V.P.
Table Seating
863-2524
Balcony Seating
431-1210

Tickets available
at the Opera Box Office
beginning October 7

SUPERNUMERARIES

Women

Dorothy Brown
Madeline Chase
Barbara Clifford
Joanne Dickson
Gina Farruggio
Janice Phillip
Nancy Kennally
Marilyn Mathers
Cynthia Milina
Edith Modie
Louise Russo
Ellen Sanchez
Shelley Seitz
Laurie Thompson

Men

Jesse Alexander
Steve Bauman
Thomas Carlisle
Ronald Cavin

Rudolph Cook

Burton Covell
Donald Crawford
Everett E. Evans, Jr.
Herbert Harvey
Martin Izquierdo
Kenneth Jakobs
Janusz
Julius Karoblis
Rodney McCoy
Gregorio Mendoza
Lawrence Millner
Paul Newman
James Preovolos
Noble Edward Reynolds
Paul Ricks
Raymond Salazar
Thomas Simrock
Jonathan Spieler
Kent Spiers
Colin Warner

David Williams

Joseph Williams
Gerald Wood

Children

Michelle Brown
Lilo Campeau
Steven Cohen
Hardy Crawford
Martha Crawford
Gregory Gillbergh
Anthony Gonzalez
Claudia Heyneman
Jennifer Heyneman
Nina Kent
Gregory Moreci
Daniel O'Connor
April Sack
Celia Sack



SPRING OPERA THEATER

produced by San Francisco Opera
Kurt Herbert Adler, General Director

APRIL 1977

at the Curran

Five delightfully theatrical operas (one double-bill)
including the American Premiere of a work
which received rave reviews
at the Holland
and Spoleto Festivals

Watch for the season announcement!

for information on membership in Spring Opera Theater 1977
please call (415) 431-1463

1976 Season Repertoire

New Production made possible by a generous gift from Cyril Magnin
San Francisco Opera Premiere

THAÏS

Massenet
IN FRENCH

Sills, Jones, Cummings, South,
Harned*/Milnes, Ahnsjö**, Malta**

Conductor: Pritchard
Production: Capobianco
Designer: Toms
Choreographer: Falco*
Chorus Director: Jones

Friday Sept 10 8PM
Gala Opening Night

Wednesday Sept 15 8PM
Sunday Sept 19 2PM
Saturday Sept 25 8PM
Tuesday Sept 28 8PM
Friday Oct 1 8PM

DIE WALKÜRE

Wagner
IN GERMAN

Knie*, Rysanek (Sept. 11, 14, 17)//
Martin (Sept. 22, 26, Oct. 2), Hesse*,
Goreniuc*, Roark, Sherrard*,
Garabedian, Jones, Harned, Petersen,
Nadler/Vickers, Sotin*, Grant

Conductor: Suitner
Stage Director: G. Hager
Designer: Skalicki

Saturday Sept 11 7:30PM
Tuesday Sept 14 7:30PM
Friday Sept 17 7:30PM
Wednesday Sept 22 7:30PM
Sunday Sept 26 1:30PM
Saturday Oct 2 1PM

New Production made possible, in part, by generous gifts from a number of arts patrons and the William H. Noble Estate

LA FORZA DEL DESTINO

Verdi
IN ITALIAN

Tomowa-Sintow, Marsee*, Jones/
Morell (Sept. 18, 21, 24)//Prevedi*
(Sept. 29, Oct. 3), Bruson, Plishka*,
Davies

Conductor: Adler
Production: Fassini*
Designer: Samaritani*
Choreographer: Guidi*
Chorus Director: Jones

Saturday Sept 18 8PM
Tuesday Sept 21 8PM
Friday Sept 24 8PM
Wednesday Sept 29 8PM
Sunday Oct 3 2PM

Kabaivanska, Marsee, Jones/Ilosfalvy,
Boyagian**, Kovats**, Capecchi, Malta,
Frank, Geiger, Davies

Conductor: Adler
Production: Fassini
Stage Director: Farruggio
Designer: Samaritani
Choreographer: Guidi
Chorus Director: Jones

Sunday Nov 7 2PM
Saturday Nov 13 1:30PM
Friday Nov 19 8PM

TOSCA

Puccini
IN ITALIAN

Rysanek (Oct. 2, 5)//Martin (Oct. 8, 10,
16, 23)/Aragall, Wixell, Trimarchi,
Johnson*, Frank, Strummer, Davies

Conductor: Peloso
Production: Ponnelle
Stage Director: Prohaska**
Designer: Ponnelle
Chorus Director: Jones

Saturday Oct 2 8PM
Tuesday Oct 5 8PM
Friday Oct 8 8PM
Sunday Oct 10 2PM
Saturday Oct 16 8PM
Saturday Oct 23 1:30PM

PETER GRIMES

Britten
IN ENGLISH

Harper, Nadler, Petersen, Cummings,
South/Vickers, Evans, Malta, Turnage*,
Crook*, Geiger, Frank, Duykers

Conductor: Pritchard
Production: Evans
Designer: Toms
Chorus Director: Jones

Wednesday Oct 6 8PM
Saturday Oct 9 8PM
Wednesday Oct 13 8PM
Sunday Oct 17 2PM
Friday Oct 22 8PM

New Production made possible by a generous gift from Cynthia Wood

DIE FRAU OHNE SCHATTEN

R. Strauss
IN GERMAN

Rysanek, Schröder-Feinen*, Hesse,
Cummings, South, Roark, Jones,
Harned, Petersen/Kastu**, Berry*,
Johnson, Alvary, Hecht, Duykers,
Hoback*, Turnage, Geiger, Byrd*

Conductor: Böhm*
Production: Lehnhoff
Designer: Zimmermann**
Chorus Director: Jones

Friday Oct 15 8PM
Tuesday Oct 19 8PM
Sunday Oct 24 1:30PM
Saturday Oct 30 8PM
Tuesday Nov 2 8PM

Kalliópe



From Greece: Classic hand woven jacket with lace edging for your holiday entertaining. Available in ecru or brown & white pin stripe. \$29.00
Order by Phone 776-0174, 776-4646, 391-1948.

1424 Grant Ave. (upper) and
900 Northpoint, Ghirardelli Square
San Francisco, Ca.
Parking Validation



VOLTAIRE SUMMIT

GEYSER PEAK

Fine Table Wines

Visit Our

Geyserville Winery

in Sonoma County

For Taste - Tours

10-5 Daily

GEYSER PEAK WINERY
Geyserville, Sonoma County, California

A VOTRE SANTÉ!

SAN FRANCISCO OPERA ASSOCIATION Announces its 1976 Annual Opera Fund Drive

Here's a toast to San Francisco Opera and its 54th international fall season.

Keeping it in good health and good spirits for future generations should concern all opera goers. Even with capacity houses, ticket sales account for slightly over 60% of our annual operating funds. The remaining 40% is raised in a variety of ways: through our guarantor program, federal and municipal funds, new program sponsors — and our annual community fund drive.

We depend on you to help us break even. Let's not wait for an unforeseen crisis to realize the importance of one of our most treasured community possessions. Give as much as you can to insure continued excellence and growth.

- Friend:
\$10 to \$99
- Contributor:
\$100 to \$499
- Donor:
\$500 to \$999
- Benefactor:
\$1,000 to \$4,999
- Sustaining Patron:
\$5,000 and over
- Business Patron:
\$2,500 and over

Name _____

Address _____

City _____

State _____ Zip _____

Phone _____

Send to:

San Francisco Opera Association
Development Office
War Memorial Opera House
San Francisco, California 94102
(415) 861-4008

Repertoire

continued

THE MAKROPULOS CASE

Janáček
IN ENGLISH

Silja, South, Jones, Harned/Lewis,
Evans, Crook, Hecht, Manton,
Rosenstein*, Davies

Conductor: Von Dohnanyi
Stage Director: Pountney*
Designer: Bauer-Ecsy
Production Coordinator: Ecsy*
Chorus Director: Jones

Wednesday Oct 20 8PM
Saturday Oct 23 8PM
Tuesday Oct 26 8PM
Friday Oct 29 8PM
Sunday Oct 31 2PM

New Productions made possible, in part, by a generous gift from James D. Robertson

CAVALLERIA RUSTICANA

Mascagni
IN ITALIAN

Troyanos (first 5 perfs.)//Crespin (Nov. 16, 21, 24, 27), Esham*, Petersen/Domingo (first 6 perfs.)//Lloveras (Nov. 21, 24, 27), Janulako

and

I PAGLIACCI

Leoncavallo
IN ITALIAN

Rogers* (first 6 perfs.)//Kabaivanska (Nov. 21, 24, 27)/Domingo (first 6 perfs.)//Prevedi (Nov. 21, 24, 27), Wixell (first 6 perfs.)//Glossop (Nov. 21, 24, 27), Ellis*, Frank, Hoback, Davies

Conductor: Schermerhorn
Production: Ponnelle
Designer: Ponnelle
Chorus Director: Jones

Wednesday Oct 27 8PM
Saturday Oct 30 1:30PM
Friday Nov 5 8PM
Wednesday Nov 10 8PM
Saturday Nov 13 8PM
Tuesday Nov 16 8PM
Sunday Nov 21 2PM
Wednesday Nov 24 8PM
Saturday Nov 27 8PM

World Premiere made possible by generous gifts from the National Endowment for the Arts, City of San Francisco, San Francisco Foundation and a number of arts patrons
In celebration of the Twin Bicentennial of the U.S.A. and the City of San Francisco

ANGLE OF REPOSE

Imbrie
IN ENGLISH

Shade *, Marsee, Garabedian/Ludgin, Lewis, Duesing**, Hecht, Johnson, Byrd, Turnage, Davies, Hoback

Conductor: Mauceri*
Production: Freedman*
Set Designer: Schmidt*
Costume Designer: Casey*
Choreographer: McFall*
Chorus Director: Jones

Saturday Nov 6 8PM
Tuesday Nov 9 8PM
Sunday Nov 14 2PM
Thursday Nov 18 8PM
(Tuesday evening prices)
Friday Nov 26 8PM

IL BARBIERE DI SIVIGLIA

Rossini
IN ITALIAN

Von Stade, Hinson/Hagegard**, Brecknock*, Capecci, Tozzi, Turnage, Duykers, Harvey

Conductor: Varviso
Stage Director: G. Hager
Designer: Siercke
Chorus Director: Jones

Friday Nov 12 8PM
Wednesday Nov 17 8PM
Saturday Nov 20 8PM
Tuesday Nov 23 8PM
Thursday Nov 25 8PM†
Sunday Nov 28 2PM

†Special Thanksgiving Night non-subscription performance, Friday evening prices

*San Francisco Opera debut
**American opera debut

REPERTOIRE, CASTS AND DATES
SUBJECT TO CHANGE

Special Events

OPERA ACTION PREVIEWS

MARIN

Previews held at Del Mar School, 105 Avenida Mira Flores, Tiburon. Lectures begin at 8:30 PM. Series registration is \$8.50; single tickets are \$2 (\$1.50 for students and senior citizens). For information, please call (415) 435-0191.

September 16
LA FORZA DEL DESTINO
Ramona Rockway and Singers

October 14
DIE FRAU OHNE SCHATTEN
Dr. Jan Popper

October 21
THE MAKROPULOS CASE
Dr. Dale Harris

November 4
ANGLE OF REPOSE
Robert Commanday

A Gala "Overture to the Previews" performance by San Francisco Opera's Brown Bag Opera singers will be held on September 23, 2 PM, at the Sausalito Women's Club, 120 Central Avenue. A donation of \$3.00 is requested. For reservations, please call (415) 332-3922.

SOUTH PENINSULA

Previews held at the Palo Alto Community Cultural Center, 1313 Newell Road, at 7:30 PM. Series registration is \$10; single tickets are \$2.50 (\$1.25 for students with I.D.). For information, please call (415) 321-9875, or 941-3890.

September 12
THAÏS
Dr. Dale Harris

September 19
LA FORZA DEL DESTINO
Ramona Rockway

October 10
DIE FRAU OHNE SCHATTEN
Dr. Jan Popper

October 24
THE MAKROPULOS CASE
Dr. Dale Harris

October 31
ANGLE OF REPOSE
Robert Commanday

Bus Service to San Francisco Opera Performances:

Weekend bus service is available from Stanford Shopping Center. For information, please contact: Palo Alto (415) 493-8636 South Peninsula (408) 295-0073 or (415) 326-0856

JUNIOR LEAGUE OPERA PREVIEWS

All Junior League opera previews will be held at the Curran Theatre with the exception of Nov. 2, indicated below. Previews begin at 11 AM. For information, please call (415) 567-8600.

October 1
PETER GRIMES
Dr. Jan Popper

October 11
DIE FRAU OHNE SCHATTEN
Michael Barclay

October 20
THE MAKROPULOS CASE
Dr. Dale Harris

November 2
ANGLE OF REPOSE
Robert Commanday
(First Unitarian Church)

SAN JOSE OPERA GUILD PREVIEWS

Two series are offered: Daytime Series, presented in cooperation with West Valley College Community Services and Inter-Disciplinary Enrichment Seminars, at Saratoga Community Theater, Fruitvale Avenue, Saratoga, California. Previews held from 10 AM-12 noon. For 1/2 unit of college credit, please contact LS-90 Series Office, West Valley College, (408) 867-2200, extensions 407 or 363. For other information, please call Mrs. Jerrine Jeffery, (415) 984-3636 or Artie Nicholson, (415) 967-3590.

September 10
THAÏS
Dr. Dale Harris

September 24
TOSCA
James H. Schwabacher, Jr.

October 7
PETER GRIMES
Dr. Jan Popper

October 22
THE MAKROPULOS CASE
Dr. Dale Harris

Evening Series, presented in cooperation with De Anza College as part of their Seminar Lecture Series-90. Previews held from 8-10 PM at De Anza College Campus, 21250 Stevens Creek Boulevard, Cupertino, California. There is a \$2 advance registration fee which permits entrance to one or all previews. For a 1/2 unit of college credit, please contact SLS-90, De Anza College, (408) 257-5550. For other information, please call (415) 984-3636 or (415) 967-3590.

September 17
LA FORZA DEL DESTINO
Dr. Jan Popper

October 1
DIE FRAU OHNE SCHATTEN
Dr. Arthur Regan

October 15
CAVALLERIA RUSTICANA/I PAGLIACCI
James H. Schwabacher, Jr.

October 29
ANGLE OF REPOSE (The Novel)
Dr. Wallace Stegner, Author

November 5
ANGLE OF REPOSE (The Opera)
Robert Commanday

San Francisco Opera presents internationally renowned

Leontyne Price

in recital

War Memorial Opera House
Sunday, November 21, 8 p.m.



Miss Price, one of the world's best loved sopranos, with David Garvey at the piano, will include in her program some of the most beloved lieder, selected operatic arias, and spirituals.

Tickets available at the Opera Box Office

Orchestra	\$15.00
Grand Tier	15.00
Dress Circle	12.00
Balcony Circle	10.00
Balcony A-E	8.00
Balcony F-H	6.50
Balcony J-L	5.00
Box Seat	18.00

For ticket information
(415) 431-1210



Food you can find in
only two places
— China and our
kitchens
Lunch/Dinner/Cocktails
Banquets to 300

"House of 1,000 Epicurean Delights"

the Golden Pavilion

SAN FRANCISCO:
Sacramento & Grant Ave. • 392-2334
LOS ALTOS:
El Camino and Los Altos Ave. • 941-5656
Adjoining Golden Pavilion Motor Inn
941-0360



NARSAI'S

OUTSTANDING
FRENCH CUISINE
&
Superb Catering

Sundays thru Thursdays—
5 pm to 10 pm
Fridays thru Saturdays—
5 pm to 12 pm

385 Colusa Avenue
in North Berkeley
Kensington, Ca 94707
527 7900

Special Events

continued

Bus Service to San Francisco Opera Performances:

Weekend bus service is available from San Jose, Los Gatos and Palo Alto. For information, please call (408) 295-0073, 296-4597 or 241-9381.

UC-BERKELEY EXTENSION LECTURE SERIES

DR. JAN POPPER LECTURES will be given at 2 locations:
San Francisco Series, Monday evenings at 7:30 PM at UC Extension Center, 55 Laguna. Series registration is \$40; single tickets are \$5, on a space available basis, payable at the door. For further information (on either the San Francisco or Berkeley series), please call (415) 861-6833, or 642-4111.

September 13
THAÏS

September 20
DIE WALKÜRE

September 27
LA FORZA DEL DESTINO

October 4
TOSCA

October 11
PETER GRIMES

October 18
DIE FRAU OHNE SCHATTEN

November 1
THE MAKROPULOS CASE

November 8
CAVALLERIA RUSTICANA/I PAGLIACCI

November 15
ANGLE OF REPOSE

November 22
IL BARBIERE DI SIVIGLIA

Berkeley Series, Tuesday evenings at 7:30 PM at 125 Morrison Hall on the Berkeley Campus. Series registration is \$20; single tickets are 5, on a space available basis, payable at the door.

September 21
DIE WALKÜRE

September 28
LA FORZA DEL DESTINO

October 5
TOSCA

October 12
PETER GRIMES

October 19
ANGLE OF REPOSE

NAPA COMMUNITY COLLEGE LECTURE SERIES

For the fourth year Napa Community College is offering a ten-week course called ADVENTURES IN OPERA. The course, which introduces the Sunday Series at San Francisco Opera, will be held in the Library of Ridgeview Junior High School, 2447 Old Sonoma

Road, Napa, California, on Wednesday nights from 7-9 p.m. Registration for the entire series is \$7.00. Ernest A. Fly will again teach the course, using his collection of complete opera recordings, Metropolitan Opera filmstrips, and also introducing guest speakers and vocal artists. For further information, please call Mr. Fly at (707) 224-6162.

September 15
THAÏS

September 22
DIE WALKÜRE

September 29
TOSCA

October 6
PETER GRIMES

October 13
DIE FRAU OHNE SCHATTEN

October 20
THE MAKROPULOS CASE

October 27
LA FORZA DEL DESTINO

November 3
ANGLE OF REPOSE

November 10
CAVALLERIA RUSTICANA/I PAGLIACCI

November 17
IL BARBIERE DI SIVIGLIA

YWCA LECTURE SERIES

For the fifth year, the Downtown Center of the YWCA is offering an eight-week course called OPERA SPECTRUMS. The course, held on Monday evenings from 7-9 p.m., at 620 Sutter Street, includes the use of recordings, rare films, slides, live vocal and musical demonstrations, and group discussions of performances attended. Music critic, William Aguiar, Jr., will be the lecturer. Series registration is \$30; single tickets are \$4, on a space available basis, payable at the door. For further information, please call (415) 775-6500.

September 20
THAÏS

September 27
DIE WALKÜRE

October 4
LA FORZA DEL DESTINO

October 11
TOSCA and THE MAKROPULOS CASE

October 18
DIE FRAU OHNE SCHATTEN
and *PETER GRIMES*

October 25
CAVALLERIA RUSTICANA/I PAGLIACCI

November 1
ANGLE OF REPOSE and a Survey of contemporary American opera

November 8
IL BARBIERE DI SIVIGLIA

SAN FRANCISCO OPERA

Broadcasts

made possible by Standard Oil Company of California
and the L. J. and Mary C. Skaggs Foundation of Oakland, California.

KKHI—AM 1550/FM 95.7	San Francisco
KFAC—AM 1330/FM 92.3	Los Angeles
KING—FM 98.1	Seattle
KOIN—FM 101	Portland
KFBK—FM 92.5	Sacramento
KMJ—FM 97.9	Fresno
KFSD—FM 94.1	San Diego
WFMT—AM 1450/FM 98.7	Chicago
KSJN—FM 91.1	Minnesota

Friday, September 10	THAÏS
Friday, September 17	DIE WALKÜRE
Friday, September 24	LA FORZA DEL DESTINO
Friday, October 8	TOSCA
Friday, October 15	DIE FRAU OHNE SCHATTEN
Friday, October 22	PETER GRIMES
Friday, October 29	THE MAKROPULOS CASE
Friday, November 5	CAVALLERIA RUSTICANA/ I PAGLIACCI
Friday, November 12	IL BARBIERE DI SIVIGLIA
Friday, November 26	ANGLE OF REPOSE

All broadcasts will begin at 7:50 p.m. with the exception of DIE WALKÜRE,
which will begin at 7:20 p.m.

KQED FM 88.5

SUNDAY MORNING AT THE OPERA

Recorded operas with John Roszak, host.
Gene Parrish interviews artists of the 1976 San Francisco Opera season
during intermission. 11 a.m. every Sunday.

ARTS REPORTING SERVICE

Charles Christopher Mark, publisher of
Arts Reporting Service Newsletter, speaks from Washington, D.C.
on the state of the arts in the United States and elsewhere.
9:00-9:05 a.m. Monday through Friday.

KPFA FM 94.1

OPERA REVIEWS ON THE AIR

KPFA critics Bill Collins, Melvin Jahn and Bob Rose
talk about the 1976 San Francisco Opera productions
each Sunday afternoon at 4:30 p.m.

A
Collector's
Treasure



Circa 19th Century, from India . . .
a gold bracelet encrusted with rose
diamonds, rubies, emeralds, sapphires.

Designer and Creator of Fine Jewelry

A. Hagosian & Son

JEWELER 781-8220

HOTEL SIR FRANCIS DRAKE • 456 POWELL

Dine In The Opera House

Open One Hour
Before Each
Performance

Food • Beverages Desserts

Featuring
Fresh Fruit Crepes
Your Choice of
Wine, Champagne, etc.

For All Your
Catering Needs Call
864-1958

Prophet Foods

War Memorial Opera House



**SIR FRANCIS DRAKE
EDITION**
Nickel Plated \$40.00

**SIR FRANCIS DRAKE
EDITION**
Gold Plated \$50.00

**REDWOOD EMPIRE
EDITION \$35.00**

STRANDS OF HISTORY™

A PART OF THE ORIGINAL GOLDEN GATE BRIDGE

The San Francisco Bridge Company proudly announces the presentation of a unique and distinguished collector's item: an authenticated section of the Golden Gate Bridge.

Since its completion in 1936, the Golden Gate Bridge has served as a world-renowned symbol of American ingenuity and enterprise unmatched in history.

On the occasion of the bridge's 40th anniversary, the Bridge District has completed installation of new suspension cable designed to insure the safety of the bridge through the next century.

Believing that most Americans have a special affection for the Golden Gate Bridge, the San Francisco Bridge Company has preserved the old cable as mementos for people everywhere to cherish for years to come.

Those who love fine Americana will have a special appreciation for these magnificently designed four-inch, four-pound pieces. Whether you select elegant 24-carat gold, nickel plate, or the original International Orange of the Golden Gate, these handsome settings will be a unique addition to your home or office.

The world famous design firm of Walter Landor & Associates has created a base of elegant teak for the International Orange of the Redwood Empire Edition. For the gold or nickel plated Sir Francis Drake Edition, the firm designed an M-shaped base of 12-gauge, hand-polished steel covered with the finest quality glove-soft leather. Both bases bear the inscription, "Strands of History—1936-1976—Golden Gate Bridge Original Suspender Cable."

A specially minted bronze medallion, bearing the official seal of the Golden Gate Bridge Highway and Transportation District, is affixed to each cable length, and authenticates its origin. A collector's number, stamped on the reverse side of the medallion, insures the uniqueness of each piece. To avoid disappointment, please fill out and mail the reservation coupon today.

Please reserve the following settings, for a total price of \$ _____

Edition	Quantity
REDWOOD EMPIRE: International Orange	_____ @ \$35.00
EMPIRE: Gold Plate	_____ @ \$50.00
SIR FRANCIS DRAKE: Nickel Plate	_____ @ \$40.00
DRAKE: Gold Plate	_____ @ \$50.00

Check or money order enclosed. Charge to: American Express
 BankAmericard Carte Blanche Master Charge

Acct. # _____

Valid through _____

Signature _____

Name _____

Street _____ (please print)

City/State/Zip _____

Make checks payable to:
San Francisco Bridge Company
311 California Street, 7th Floor
San Francisco, California 94104

We ship anywhere in the U.S. postpaid.
Please add 6% sales tax in California. Phone
orders accepted at (415) 386-3700.

Call Toll Free: 800-227-0899
(Except Alaska, Hawaii and California)



The San Francisco Bridge Co.

SAN FRANCISCO OPERA

Guild

<i>President</i>	Mrs. Warren J. Coughlin
<i>Vice President</i>	Mrs. James J. Ludwig
<i>Vice President</i>	Mrs. John A. Traina, Jr.
<i>Vice President</i>	Mrs. Peter M. Zuber
<i>Secretary</i>	Mrs. Bruce K. Denebeim
<i>Treasurer</i>	Mrs. Allan A. Fleischer

Mrs. William Brantman
 Mrs. Joseph D. Cuneo
 Mrs. C. K. Poe Fratt
 Mrs. Thomas G. Griffith
 Mrs. Harriet M. Quarré
 Mrs. William M. Witter

Student Matinees

THE BARBER OF SEVILLE

Rossini
 IN ENGLISH

Tuesday, November 9
 Friday, November 12
 Wednesday, November 17
 Thursday, November 18
 Wednesday, November 24

BROWN BAG OPERA

A growing Bay Area entertainment favorite

October 3, Sunday—1:00 p.m.

Capwell's, 20th and Broadway, Oakland

October 9, Saturday—12:15 p.m. and 3:45 p.m.

Hearst Court, DeYoung Museum, Golden Gate Park, San Francisco

October 10, Sunday—1:00 p.m.

Columbus Day Parade, Civic Center to S.S. Peter and Paul's Church

October 20, Wednesday

DeAnza College, Cupertino, 21250 Stevens Creek Blvd.

October 29, Friday—8:00 p.m.

Sunnyvale Community Center Auditorium, Sunnyvale

Watch for announcements of upcoming performances

DINE IN A CHARMING
 FRENCH
 COUNTRY
 KITCHEN

THE PAVILION

2400 POLK STREET
 ORDWAY 3-5344

The ultimate experience
 in French Greek Cuisine

LODEON

Luncheon Cocktails Dinner
 565 CLAY ST., S.F. 434-2345
 Private Party Facilities • Valet Parking

Consistent Holiday Award Winner

THE PLAYERS

After Dinner • Piano-Bar

584 COMMERCIAL

IF YOU LOVE WINE . . .
 but hate coupons too
 small to write on:

I am interested in THE WINE DISCOVERY CLUB and/or
 PERSONAL WINE JOURNAL as a Member/ Subscriber
 Staff Member Investor Winebibber

Please send details, menus, samples, invitations—everything
 to keep me full of wine lore and liquid.

YOUR NAME _____ PHONE _____
 ADDRESS _____
 CITY _____ STATE _____ ZIP _____

MAIL TO: Fred Cherry ■ 470 Columbus Avenue
 San Francisco, California 94133 ■ (415) 982-9624

ISRAEL

Visit your tree. Find your roots.

2-week vacation package from \$699 per person, double occupancy.

Included are round trip air travel direct from the West Coast on a World Airways 747 jumbo jet. A week in Jerusalem at the first class Basel Hotel.

A week in Tel Aviv at the first class Hotel Shalom. Plus sight-seeing in Tel Aviv, welcoming receptions, a Tour Escort throughout and all of the necessary transfer charges and tips.

Send for our free brochure today. Flights begin departing every other week from November 21, 1976.

World Airways is a U.S. certificated supplemental air carrier. Member NACA and IACA.

Approved by CAB and Israeli government.



**Creative
World
Travel**

One Market Plaza,
Stewart Street Tower,
Suite 2201, San Francisco, CA
94105, (415) 543-6789

Now is the time...

to let go of tensions and anxieties
TODAY is the day to become
acquainted with an *outstanding*
Bay Area authority on Yoga.



YOGA with MARA

402 Alta Loma Avenue
Daly City, California
phone (415) 755-0631

merola opera program

San Francisco Opera Auditions
applications available now

Please contact:

Merola Fund
War Memorial Opera House
San Francisco CA 94102
Telephone (415) 864-1377

SAN FRANCISCO OPERA ACTION

Chairman	Mrs. Melvin C. Britton
Vice Chairman	Mrs. Lawrence Brownson
Secretary	Mrs. John E. Baumann
Treasurer	Mrs. Nancy Downey
Immediate Past Chairman	Mrs. L. W. Thomas May

BAY AREA CHAPTERS

San Francisco	Mrs. Patricia Wright Lewis
Marin	Miss Suzanne Turley
East Bay	Mr. Joseph A. Russo
South Peninsula	Mrs. Jonathan B. Gifford
North Peninsula	Mrs. Carl Witkovich

San Francisco Opera ACTION was created in 1967 to increase awareness in San Francisco Opera and to stimulate interest in opera in general. Opera ACTION works in close cooperation with the Company's staff, enabling it to greatly extend its reach and activity.

Those interested in actively working on behalf of San Francisco Opera should call:

In San Francisco	861-4008
In Marin	435-0191
In the East Bay	339-1128
In the North Peninsula	341-2249
In the South Peninsula	321-9875



"We can't believe we're really here. We kept saying, we'll do it someday. Well, with a little help from our Master Charge, we made that someday happen today."



*Master Charge.[®]
Because sometimes,
someday is too far away.*



Seville and the quest for perfection.

An American success story.

Few cars in so short a period of time have so captured the imagination of the motoring public as this car. Seville by Cadillac. At its introduction, this was a new kind of luxury car...designed for American tastes but at home anywhere in the world. The car complete—the first American car to combine international size and styling with Cadillac comfort and convenience.

A credit to its engineering.

So well-engineered was it that a number of Seville's design concepts have been incorporated in the 1977 Cadillacs that we proudly label the next generation of the luxury car. But Seville remains unique. And the quest for perfection goes on.

The quest.

Seville was a great car when it was introduced. It is an even more refined car today. For it is our policy to constantly seek out ways to enhance Seville—and as we find them they are incorporated into the car. There are many such refinements. Some might appear minor. Some not so minor. Altogether,



Four-wheel disc brakes.



they make Seville an even more desirable car choice for 1977. Examples of these refinements include the following:

Four-wheel disc brakes.

They are standard equipment. Combined with a power brake booster, they provide the braking capability you would expect of one of the world's best-equipped cars.

A retuned suspension system.

You might never notice the difference. But we would. So we retuned the suspension system. Complementing the suspension system are special Butyl® rubber body mounts to provide vibration-dampening qualities—for both vertical and lateral movement.

Styling refinements.

The timeless styling of Seville has been enhanced by a new, more distinctive grille. And you may now select either the vinyl 'op or the stylish simplicity of an all-metal

roof. All other styling remains happily unchanged.

A unique American luxury car.

Most important, it's a Seville—designed and engineered to be one of the world's great cars. A car of innovation—incorporating the latest American technical achievements. Such as its Electronic-Fuel-Injected Engine with an on-board analog computer. It's a beautiful road car. As a matter of fact, Seville just might be the best-performing car you've ever driven. There's only one way to know. Call your Cadillac dealer and have him arrange a test drive for you. Haven't you waited long enough?

Seville
BY CADILLAC

There's money in your house. We'll prove it.

As a California homeowner, you may have overlooked an excellent source of a loan: the hidden borrowing power in your home—your equity. Now, with a Wells Fargo Homeowner Loan, you can use this value to borrow from \$5,000 to \$20,000 (or more) for your children's college education, vacations—whatever money alone has kept you from doing.

With the Wells Fargo Homeowner Loan Program, payments are low since repayment can be spread up to ten years. Rates are substantially below those of regular installment loans. Your loan is secured by a deed of trust that doesn't in any way affect your first mortgage. And you can repay your loan at any time without prepayment penalties.

Check this chart for the amount and schedule that suits your plans (other terms are also available). Then check with your nearest Wells Fargo Bank office for more details and a Homeowner Loan application.

EXAMPLES OF TYPICAL HOMEOWNER
LOAN PAYMENTS

Amount Borrowed	Monthly Payment	Term	FINANCE CHARGE	Total Payment
\$ 5,000	\$ 88.26	7 yrs	\$2,413.84	\$ 7,413.84
5,000	71.74	10 yrs	3,608.80	8,608.80
7,500	132.40	7 yrs	3,621.60	11,121.60
7,500	107.60	10 yrs	5,412.00	12,912.00
10,000	176.53	7 yrs	4,828.52	14,828.52
10,000	143.47	10 yrs	7,216.40	17,216.40

ANNUAL PERCENTAGE RATE: *12%
*ANNUAL PERCENTAGE RATE PRIOR TO CLOSING COSTS.



Proven. Wells Fargo Bank Homeowner Loans.

MEMBER F. D. I. C.

New Production made possible, in part, by a generous
gift from James D. Robertson

Cavalleria Rusticana

(IN ITALIAN)

by PIETRO MASCAGNI

to a text by GIOVANNI TARGIONI-TOZZETTI and GUIDO MENASCI

Based on the play by GIOVANNI VERGA

Conductor
Kenneth Schermerhorn

Production Designed and Directed by
Jean Pierre Ponnelle

Assistant to Mr. Ponnelle
Jean Louis Martinoty**

Chorus Director
Robert Jones

Lighting Designer
Thomas Munn

Musical Preparation
Randall Bare

Scenery Built in
San Francisco Opera Scenic Shop

Costumes Executed by
Günter Berger, Director,
and

Sylvia Strahammer,
Costume Department
Bavarian State Opera

San Francisco Boys Chorus
William Ballard, Director

CAST

(in order of appearance)

Santuzza Tatiana Troyanos (October 27, 30,
November 5, 10, 13)
Regine Crespin (November 16, 21, 24, 27)

Turiddu Placido Domingo (October 27, 30,
November 5, 10, 13, 16)
Juan Lloveras (November 21, 24, 27)

Mamma Lucia Donna Petersen

Alfio Wassili Janulako

Lola Faith Esham*

Peasants and villagers

***American debut*

**San Francisco Opera debut*

TIME AND PLACE: EASTER SUNDAY, A VILLAGE IN SOUTHERN ITALY

First Performance: Rome, May 17, 1890

First San Francisco Opera Performance: September 24, 1927

followed by

New Production made possible, in part, by a generous
gift from James D. Robertson

I Pagliacci

(IN ITALIAN)

by RUGGIERO LEONCAVALLO

with text by the composer

Conductor
Kenneth Schermerhorn
Production Designed and Directed by
Jean Pierre Ponnelle
Assistant to Mr. Ponnelle
Jean Louis Martinoty**
Chorus Director
Robert Jones
Lighting Designer
Thomas Munn
Musical Preparation
Randall Bare
Scenery Built in
San Francisco Opera Scenic Shop
Costumes Executed by
Günter Berger, Director,
and
Sylvia Strahammer,
Bavarian State Opera
San Francisco Boys Chorus
William Ballard, Director
Marin County Day School Girls Chorus
Barry Mineah, Director

CAST

(in order of appearance)

<i>Tonio (Taddeo)</i>	Ingvar Wixell (October 27, 30, November 5, 10, 13, 16) Peter Glossop (November 21, 24, 27)
<i>Canio (Pagliaccio)</i>	Placido Domingo (October 27, 30, November 5, 10, 13, 16) Bruno Prevedi (November 21, 24, 27)
<i>Nedda (Columbine)</i>	Noelle Rogers* (October 27, 30, November 5, 10, 13, 16) Raina Kabaivanska (November 21, 24, 27)
<i>Beppe (Harlequin)</i>	Joseph Frank
<i>Two Farmers</i>	James Hoback, John Davies
<i>Silvio</i>	Brent Ellis*
<i>Pantomime by</i>	Paul Scardino* Dennis Parlato* Mary Van Perre*

Peasants and villagers

**American debut

*San Francisco Opera debut

THE OPERA TAKES PLACE IN A VILLAGE IN SOUTHERN ITALY

First performance: Milan, May 21, 1892

First San Francisco Opera performance: October 6, 1923

WEDNESDAY EVENING, OCTOBER 27, 1976 AT 8:00
SATURDAY AFTERNOON, OCTOBER 30, 1976 AT 1:30
FRIDAY EVENING, NOVEMBER 5, 1976 AT 8:00 (Broadcast)
WEDNESDAY EVENING, NOVEMBER 10, 1976 AT 8:00
SATURDAY EVENING, NOVEMBER 13, 1976 AT 8:00
TUESDAY EVENING, NOVEMBER 16, 1976 AT 8:00
SUNDAY AFTERNOON, NOVEMBER 21, 1976 AT 2:00
WEDNESDAY EVENING, NOVEMBER 24, 1976 AT 8:00
SATURDAY EVENING, NOVEMBER 27, 1976 AT 8:00

Please do not interrupt the music with applause

*Latecomers will not be seated during the performance
after the lights have dimmed in order not to disturb
patrons who have arrived on time*

*The use of cameras and any kind of recording equipment
is strictly forbidden*

*The performance will last approximately
two hours and fifty minutes*

CAVALLERIA RUSTICANA / PAGLIACCI

by KENNETH SCHERMERHORN

The ingredients that go to make up a successful opera are many, varied and often quite mysterious. It is seldom that the right combination of these ingredients concur, and seldom indeed when they concur to the extent that they do in two of the most popular operas of all time: *Cavalleria Rusticana* and *I Pagliacci*. Just why are these two pieces so popular and successful? First and by any and all means they are supremely accessible. Even more than accessible, they attack the senses with an immediacy and an urgency that is rare if not almost unparalleled. Moreover they present such an enormous tessiture of emotional thrust: from honest unadorned love to unbridled hatred, from violence of the rawest sort to the bucolic joys of serene church holidays. The libretti are so compact, so pictorial, they are almost photographic, seething with emotion and direct powerful statements. Here there are no distillations or abstractions, only the unadulterated raw material. To accompany and propel these terse statements are musical gestures that complement them. Glorious inspired melodies, great sonic climaxes, down-home tunes, uncomplicated rhythms, rhythms that travel from heart to heart without detour. These composers were supremely aware of just what the people wanted to hear, and they wrote it, and more to their credit they wrote it superbly. In *Cavalleria* and *Pagliacci*, we do not find the deep satisfactions of musical construction or architectonics; the gratifications of musical logic and proportion are here rare indeed. This heart is all sleeve and quite deliciously so. The stories of both operas spin themselves out in a matter of hours. Such is the compactness and directness of their message. The musical language is also compatibly very direct and urgent. I find a striking similarity between the two which I suspect is not alarming in that they are so closely contemporary. Some of the melodies are almost interchangeable and in fact I think very often for the non-musician the melodies can be easily misidentified as coming from one opera or the other. There are also structural concatenations between the two: for example in the device of a vertical occurrence or a chord that both composers use frequently and to fullest advantage. This chord appears for example in Pagliaccio's "Vesti la giubba".



The disturbing tension created by the simultaneity of these beginning four notes is a common signature of both composers. It is also a frequent horizontal i.e. melodic statement. For example the fragrant opening chorus of *Cavalleria*:

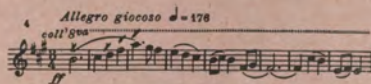

outlines the same four notes.

It is significant that these works represent a break, a notable departure from the tradition that preceded them. The Rossini-Bellini-Donizetti-Meyerbeer-Verdi idea of lyric theater accepted as a direct point of departure genuine vocal virtuosity. That is not to say that more than virtuosity might be applied to the roles they created, but vocal agility and gymnastics remain in the works of these composers, the sine qua non for the interpreter. Even Wagner, so removed from the set pieces and the fioritura of this tradition, demands such a great deal of sheer vocal prowess. However with Mascagni and Leoncavallo, we have for the first time more than a projection of vocal effort alone, rather, an exposition of a personality, a full rounded character. More stress is placed upon dramatic ability and less upon the sole exploitation of vocal gymnastics. These operas mark the beginning of the actor-singer, an event which enabled certain singers who otherwise may not have formerly had great careers to achieve stardom and fame by virtue not only of their vocal qualifications but also of their acting ability. The verismo operas of the young Italian composers set new standards of singing and acting that were made to order for such artists as Calvé, whose portrayal of Santuzza quickly eclipsed Bellincioni's original which was by all accounts, vocally superior. And also for Madame Farrar, for example, whose Madame Butterfly is recalled most often for its thespian conviction.

The phenomenon of this school of dramatic style began essentially with Giovanni Verga. Verga, who lived from 1840 to 1922, began his career as an extremely successful writer of commercial and timely romances, but the reading of a ship's log one day, with its unadorned truth, inspired him to abandon these artificially distended romances. Thereafter he wrote with great frugality and pungency about life as he witnessed it; about the peasants and fisherman of his native Sicily, and in so doing, became the leader of a school of writing which in Italy, was duly dubbed *verismo*. The musical inheritors of this style of dramatic presentation were, first of all, tonight's composers Pietro Mascagni and Ruggiero Leoncavallo. They were soon joined by other Italians like Giordano, Puccini, Zandonai, et al and in France by Massenet, Saint Saëns, Charpentier, Thomas and Bizet, just to name a few.

CAVALLERIA RUSTICANA

"I was crowned before I became king." So lamented Pietro Mascagni in "Mascagni Parla" many operas after *Cavalleria*, his first and virtually only successful effort. But the music of that first effort is undeniably and truly inspired. What it may lack in compositional depth it certainly makes up for in gorgeous tonal painting. This is some of the most accurate musical depiction that one can ever come across. It fairly

reeks of atmosphere; it is music that attacks the olfactory and the tactile as strongly as it does the aural senses if that's possible. *Cavalleria* when it appeared as a short story by Verga was a mere ten pages in length and even much of this was a description more or less blow by blow of the gory knife duel between Alfio the cuckolded husband of Lola and the young buck Turiddu. A free paraphrase of the action sees Alfio scoring first with a stab to the arm. Turiddu then manages a devastating thrust to the groin which leaves Alfio groaning and groveling in pain. In a typical and wildly desperate grasp at survival he blinds Turiddu with a handful of dust and proceeds to finish him off with knife thrusts to the stomach and throat. We are spared this verbal close-up in the final libretto by Targioni-Tozzetti and Menasci but the laconic emotional statement is otherwise intact and very present.

Pietro Mascagni at the tender age of 27 won first prize with this piece in a one-act opera competition sponsored by the publishing house of Sonzogno and with its first performance in Rome on May 17, 1890 became rich, famous and powerful virtually overnight. The subject of *Cavalleria*, as with many of Verga's verismo works, had wide and immediate appeal in the ebbing hours before the turn of the century. Verga himself created a popular play out of the materials and the role of Santuzza became one of Eleonora Duse's greatest vehicles. It surely must have made a very stark impression upon Mascagni, for he created a perfect musical mate for its compact and unswerving line. He tried 14 more times to repeat his success but outside of a few brief pages never managed to match its magic. He spent his later years in ignominy as a dedicated and heralded fascist and helped to perpetrate some of those flagrant artistic heresies that were so common during that lamentable moment of Italy's history.

Cavalleria begins with an orchestral prelude and from the very first notes of an otherwise lovely and reverential melody Mascagni introduces some underpinning of a poignant open fifth similar to ex. 1 to presage the tension and tragedy which is to come. The prelude features an aria by the tenor Turiddu, which was quite a daring and inspired gesture at that time. It is in the rhythm of a Siciliana, a sort of lazy ternary measure, a lilting 6/8. Act I opens with a chorus of women alternating with a chorus of men in setting an atmosphere of bucolic tranquility and joy.

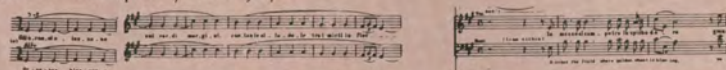

These two choruses are then combined in one of Mascagni's rare moments of technical display and this is immediately followed by a scene between Santuzza and Mamma Lucia, a scene in which the drama begins to unfold as Santuzza confesses that she has been made pregnant by Turiddu, her betrothed, and so excommunicated from the church which in Sicily meant from society as well. We also learn that Turiddu who supposedly has gone to Francofonte to purchase wine for his mother's shop has in fact been seen in the village that very morning. This dialogue is interrupted by the entrance of Alfio the merchant. This music

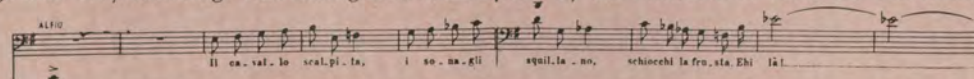

is a remarkable display of carefree machismo and boundless swagger. He is joined by the chorus and the section ends in a great burst of joyful song after which the chorus disperses, filing into the church for the celebration of mass, it being Easter Sunday. The plot is then extended by a confrontation between Mamma Lucia and Alfio during which we learn that Alfio too has seen Turiddu that very morning in fact hanging around his house. The next scene, with some of the most climactic passages of the score, is between the chorus singing from within the church a Regina Coeli and Santuzza and Mamma Lucia joining them in a tune not altogether unreminiscent of a college *alma mater*.

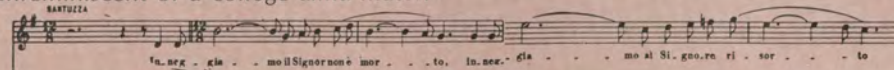

(This is in no way a critical condemnation since into the same category of tunes I would place the theme of the first movement of the "Archduke" Trio of Beethoven.) The following scene between Santuzza and Mamma Lucia contains some of the quietest and most contemplative and sublimely inspired measures of the opera. The famous "Voi lo sapete, O Mamma" which is Santuzza's major aria is one of the most popular excerpted pieces and in a brief four minutes fleshes out in its complete fullness the character of this very complex woman. A lengthy vocal skirmish then ensues between an accusing Santuzza and an irritated Turiddu, which builds to a tremendous and intense climax. Then in a most abrupt and inspired dramatic coup they are interrupted by the entrance of Lola who sings a nondescript and innocuous tune, at the conclusion of which Lola chides Santuzza for not going to church. Lola for her part does not seem to share the scruples of Santuzza and in her own time leaves them and enters the church. She is followed by an impatient and fed up Turiddu, ignoring the soulful pleadings of Santuzza. This emotional duet that was so cunningly interrupted by Lola's entrance reaches the dramatic axis of the piece as Santuzza climactically shouts at the retreating Turiddu the evil curse "A te la mala Pasqua!" Santuzza has now reached such a point of unabated jealousy that she seeks out Alfio and tells him that he is being cuckolded by Turiddu. This scene terminates with Alfio's promise to get revenge and in one of those moments that can only happen in opera we have the simultaneous statement of Santuzza's pentametric lamentation "Infame io son" and Alfio note for note singing "Vendetta avró." The opera stage is certainly the only condition under which you can logically have two people expressing two diverse ideas in precise rhythmic unison and have it make sense. With all this tension the subsequent and immemorial intermezzo is more than appropriate; it is absolutely necessary. The melody of the intermezzo is certainly one of the most innocently beguiling and quietly poised ever conceived. Here there are very few architectural complications and fewer still technical manipulations so common to later 20th century composition, merely melody for melody's sake. Church bells again introduce the chorus as they exhort each other to return to their homes and the attendant joys. Turiddu and Lola also exit the church and pass a few significant words, after which Turiddu invites Lola and the townspeople to join him in a glass of wine. The famous

drinking song of Turiddu then follows. He is joined by the chorus and Mascagni builds yet another powerful and joyous climax. Enter Alfio with severe abruptness, and after being offered a glass of wine by Turiddu replies that the wine would poison him. Turiddu pours the wine on the ground. The challenge is then made and accepted to fight to the death, sealed with a bite from Turiddu on Alfio's ear. Turiddu requests and is granted a moment to visit with his mother, Mamma Lucia. He touchingly bids her goodbye and asks her to take care of Santuzza and then requests another kiss. A roar of orchestral music paints the violence and primitive tragedy that is about to transpire. Turiddu leaves for his fatal rendezvous with Alfio and the orchestral climax is interrupted for the last time to allow the dramatic statement from the townspeople, "Hanno ammazzato compare Turiddu" ("They have killed Turiddu.") One last scream of confirmation and the closing bars bring down the curtain on a very special tragedy.

I PAGLIACCI

The libretto for *Pagliacci* which was written by the composer himself is said to be derived directly from a court case over which Leoncavallo's father presided when Leoncavallo was a child. This fact was divulged when Leoncavallo himself was being sued for plagiarism. The idea of the play within a play is of very antique origin and has been used by many playwrights and composers, but very seldom has it been used to greater advantage, than in this opera. Leoncavallo, as a young man studied music very seriously indeed, and among his idols he listed none other than Richard Wagner whose Ring Cycle he planned to emulate in a trilogy about the Borgias. At the outset, he was not at all successful and as many other unsuccessful young composers he found himself playing in cafes and bordellos for a living; Brahms and Hindemith did the same. The staggering and startling success of Mascagni's work led Leoncavallo to quickly compose this opera and send it to the same publisher, Sonzogno, who accepted it immediately and prepared it for its first performance. The first performance of *I Pagliacci* was conducted by another young man named Arturo Toscanini, and it was an immediate, instantaneous "successo strepitoso." Like Mascagni, Leoncavallo tried again and again to repeat his success but each time in vain. He was by all accounts not a happy man and very frustrated, but nonetheless respected for that initial success. He was quite an accomplished conductor, according to some accounts, and as a matter of fact conducted in San Francisco five years before his death in 1918.

The action of *Pagliacci* takes place just a little north of the setting for *Cavalleria*, in a province of Italy called Calabria, which rivals Sicily for primitive plumbing and poverty. It is also on a church holiday, the feast day of the Assumption of the Blessed Virgin. The beginning of the brilliant overture gives way in a brief flash to the first statement of that strikingly sad melody that later Canio will sing with such passion in "Vesti la giubba." A brief reprise of the first motif makes way for the entrance of Tonio, who introduces himself to the audience as the prologue. He announces to us in very elegant musical terms that this is not really a creation of fiction but a true story and he fervently hopes that when we see before us the drama unfolding we will remember that actors are men and women just like ourselves who are passionate, who can cry and suffer and rejoice. He concludes with the observation that this is an inhospitable world and we all breathe its air together. Reality or fiction judge for yourselves. A very raucous trumpet and drum on the stage open up Act I as the company of pagliacci, or clowns, arrive on the scene. All the villagers gather round and sing "Son quà." ("They are here, they have arrived") in a rousing and moving chorus. If music can be said to have genuinely nationalistic character, I think this would be proof of the proposition. There is something so peculiarly Italianate about *I Pagliacci* in general and this chorus in particular. After the chorus, Canio, who is the proprietor of the show and who is obviously one of the favorites of the town, delivers a speech with some comic sidelines inviting them to the performance that evening which by the way will take place at "ventitre ore" or 11 p.m. He synthesizes in his brief aria what they will see. That the hero will return home to find his wife in the arms of another and of the snare he sets to get his revenge. This all accomplished over a delightful waltz. The animated crowd accepts the invitation with delight. Tonio, our buffoon, now tries to help Canio's very pretty young wife, Nedda, down from the wagon but gets for his efforts a box on the ear from the jealous husband Canio. Tonio bows to this mistreatment by his boss but reminds him, under his breath, that he'll pay for it. The crowd, through its spokesman, one of the farmers, invites Canio to the tavern for a glass. He accepts with alacrity and makes to leave. Tonio, who has also been invited, begs off. The peasant then laughingly warns "watch out, Pagliaccio, I think he has other reasons to stay behind." Canio, in a very moving aria, before Nedda, the whole troupe and the villagers, states the premise of his feelings, that what you're saying is no joke, that the theater and life are not the same. This is a very focal dramatic point and is really the statement, concise as it is, of the whole philosophic view of the libretto. It ends after some musical discussion, by Canio singing the line, "Adoro. la mia sposa." ("I love my wife.") with a simplicity and affection that is most touching. An oboe is now heard on the stage which reminds the villagers that vespers are at hand. They proceed to sing a chorus imitating the sounds of bells and repeating some poetry whose atavistic sources are surely lost in antiquity. As this chorus gracefully dies away Nedda has a scene all by herself on the stage in which she demonstrates to us her naive philosophy and also infatuation with life in general and a lover named Silvio in particular. She reaches a conclusion on a high A-sharp and with it brings in the buffoon Tonio, who is in love with Nedda. Ugly as he is, he finds in Nedda the beauty and the purity, the good life that he never had. Unfortunately his ardor, even his honesty, is wasted on the frivolous and lighthearted Nedda who repulses his entreaties and laughs at him unmercifully. This is quite an extensive duet and one in which neither participant can truly or properly understand the feelings of the other. The music assists them in the pursuit of this misunderstanding in presenting yet another totally removed aspect and of not paying any attention to either one of them. In any case, he professes deep and lasting love for Nedda and she repays him by striking him in the face. He runs off swearing revenge. Now a rather sensuous phrase in the orchestra

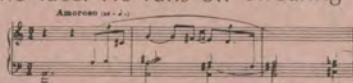

announces the arrival of Silvio, the lover whom Nedda had been dreaming about earlier. They sing a very touching duet in which they pledge love to one another. He then begs her to run off with him that very evening. She resists at first but finally consents. Here is a marvelous duet, uncomplicated by abstruse compositional devices, retrograde inversions, elongations, foreshortenings, or any other intellectual devices that may cloud Leoncavallo's compositional mind, again, just melody spinning out on top of melody; and the ease with which it accomplishes its end is quite stunning. It concludes in a moving embrace, which is interrupted by the return of Tonio and Canio. They arrive just in time to hear Nedda sing on an A pedal point above the aforementioned sensuous melody "a stanotte e per sempre tua saró." ("Until this evening and for always I will be yours.") A chase ensues but Silvio manages to escape. Canio comes back and threatens to kill his Nedda if she does not reveal the name of her lover. She refuses and she would be done in then and there except for the fact that it would reduce the length of the opera considerably, and for that reason he is restrained by Tonio, who acts as a kind of dramatic Deus ex machina throughout. Tonio calms Canio by telling him that it's better to wait for revenge: "Let's now have a performance, the show must go on." The next seven pages of score are probably the most well known in all opera. If nothing else had occurred in the life of Ruggiero Leoncavallo but these seven pages he would still be immortally remembered for "Vesti la giubba." It has always seemed to me a very inspired idea that the aria and the act end on a low E in the string basses alone. As the lowest note on the string bass it has in it a quality of the simplest and most direct sort of despondency. He mourns that he is not a man but only an actor the people pay to amuse them. He must laugh through his tears and the public will applaud. His agony is quite boundless and exquisitely rendered. An orchestral interlude separates this from the second act of the opera and manages to maintain a continuation of Canio's mournful meditations. Act II opens with an abrupt change of aural sensation with more of the raucous trumpet and drum. First of all there's a chorus of townspeople who are gathering to see the play, which if for no other reason is remarkable because of the very first statements.

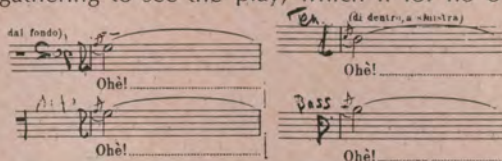

This musical adornment is used often throughout the evening. It is properly an accent or mordent and can be heard in much of the folk music in the south of Italy, Sicily, and the Mediterranean countries. Very idiomatic, it seems to express joy and sadness with equal ease and is not unlike in effect to the first utterance of a cry. Gradually during this chorus the people manage to take their seats after much confusion and among those we find Silvio who is occupying a seat right in front. Nedda who is winding among them collecting money manages to exchange some words with him. Canio, she explains, did not see him and their plan to elope after the performance remains the same. At last the play begins, and begins very elegantly with the orchestra playing a minuet. Nedda who is now in the play as Colombina seems to be awaiting someone. She informs the audience that her husband will not return until later that evening. Arlecchino is then heard, via the telephone, in a brief serenade professing his undying adoration. Before Arlecchino can make his entrance however, Taddeo, i.e. Tonio, arrives. Colombina has sent him out to buy a supper at the trattoria. He professes love but she wants her chicken. A very curious sign of the times is forcefully represented here in that she demands of Taddeo how much this chicken dinner albeit without wine, has cost her. He replies, "1.50," that is, 1 lira and 50 centesimi. In the four fleeting generations since this opera's premiere, there have been, as we are supremely aware, numerous and considerable periods of inflation. In any case, 1 lira and 50, which was worth then about 35 cents, today would be worth approximately one tenth of one cent in U.S. dollars. Enough of international economics. Arlecchino, who is played by Beppo, enters with a very good bottle of wine and sends Taddeo out on his ear. The lovers then prepare to enjoy their meal and each other and do so until Taddeo re-appears with the warning that Pagliaccio is coming. The lovers pretend to be genuinely perturbed by this and Arlecchino escapes. Colombina calls after him with the very words she had sung earlier to her real lover Silvio, "Until this evening and for always I will be yours," a line which Canio-Pagliaccio overhears and which promptly drives him to forget his assumed role. The duet that follows between Pagliaccio and Colombina staggers drunkenly between the play and reality. Pagliaccio is Canio and reality; Nedda is still Colombina and the play. The music as before in the duet between Nedda and Tonio is totally non-committal. The audience at first laughs but gradually the villagers come to realize that this is no longer a play. Beppo tries to interrupt but Tonio craftily holds him back. Totally unhinged by his own anger and jealousy, as Nedda continually refuses to divulge the name of her lover, Canio rushes at her with his knife. With one final statement by Nedda of their love theme, ending in her refusal to come forth with her lover's name, Canio stabs and kills her. She in desperation cries for help and calls out the name of her lover Silvio. Finally he has the name, and as Silvio rushes toward Nedda, Canio stabs and kills him as well. The aroused spectators seize then the stupified Canio and he drops the knife to the floor. At this point in Leoncavallo's original conception, he has Tonio address the audience with the ironical conclusion, "La commedia è finita." ("The play is over.") Since Caruso, however, it has been the tradition in most opera houses in the world, that the tenor should utter this final devastating line, which by some accounts were the last words also uttered by Ludwig van Beethoven, just before his death. In both cases I suspect the irony is justified and deserved. The opera concludes seconds later with one final statement of melody which was heard in the introduction and which is the climax of Canio's famous "Vesti la giubba," "Ridi, Pagliaccio, sul tuo amore infranto." ("Laugh, Pagliaccio, over your shattered love.")



Box Holders

Regular Subscription Series

A

Mr. & Mrs. Kurt Herbert Adler

B

Mr. & Mrs. Burlington Carlisle
Mr. & Mrs. A. Adrian Gruhn
Mrs. Jacob Gould Schurman, III

C

Mr. & Mrs. Richard P. Cooley
Mr. & Mrs. Milton H. Esberg, Jr.
Mrs. Ernest O. McCormick
Mrs. Paul A. Miller

D

Mr. and Mrs. Robert Cahill
Mrs. Andre de Limur
Mr. & Mrs. Robert C. Harris
Mr. & Mrs. Thomas Carr Howe

E

Mr. & Mrs. Harry Hastings
Mrs. Rudolph Light
Mr. James D. Robertson
Mr. & Mrs. F. Karl Schoenborn

F

Mrs. Robert Watt Miller

G

Mr. & Mrs. Otto N. Miller
Mr. & Mrs. Edward W. Scripps
Mr. & Mrs. Brooks Walker
Mr. & Mrs. Brooks Walker, Jr.

H

Mrs. Angelina G. Alioto
Mr. & Mrs. John Norton Breeden
Mrs. Felix McGinnis

J

Mr. & Mrs. Joachim Bechtle
Mr. & Mrs. I. W. Hellman
Mrs. Kenneth Monteagle
Mr. & Mrs. John P. Renshaw
Mr. & Mrs. Richard C. Walker

K

Mr. & Mrs. Edgar F. Kaiser
Mr. & Mrs. Edmund Littlefield

L

Mrs. G. Grace Benoist
Mr. & Mrs. Henry Cartan
Mrs. Nion Tucker

M

Mrs. Mortimer Fleishhacker

N

Mr. & Mrs. Walter M. Baird
Mr. & Mrs. R. Gwin Follis
Judge & Mrs. William H. Orrick, Jr.

O

Mr. & Mrs. Adolphus Andrews, Jr.
Mr. & Mrs. Gordon P. Getty
Mr. & Mrs. Gorham B. Knowles
Mr. & Mrs. George A. Pope, Jr.

P

Mr. & Mrs. Reuben W. Hills, III
Mrs. Carlos J. Maas
Mr. & Mrs. Robert Folger Miller
Mrs. Muriel McKeivitt Sonne

Q

Mrs. F. J. Hellman
Mr. Cyril Magnin
Mr. & Mrs. Walter Newman
Mr. & Mrs. Edwin A. Seipp, Jr.

R

Mr. & Mrs. A. H. Brawner
Mr. & Mrs. Richard C. Ham
Mr. & Mrs. Jaquelin H. Hume
Mr. & Mrs. John S. Logan

S

Mr. & Mrs. Walter A. Haas
Mr. & Mrs. Daniel E. Koshland
Mr. & Mrs. Robert J. Koshland
Mrs. Louis Sloss

T

Mr. & Mrs. John B. Cella, II
Mrs. Griffith Henshaw
Mr. & Mrs. William G. Henshaw
Mr. & Mrs. Robert C. Leefeldt

U

Mr. & Mrs. Malcolm Cravens
Mrs. Charles L. Harney
Mrs. Paul L. Wattis

V

Mr. & Mrs. Prentis Cobb Hale
Mr. & Mrs. William H. Hamm, III
Mr. & Mrs. James Ludwig
Mr. & Mrs. John N. Rosekrans

W

Mr. & Mrs. Selah Chamberlain, Jr.
Mr. & Mrs. Richard K. Miller
Mr. & Mrs. Augustus Taylor, Jr.

X

Mr. & Mrs. Louis Petri
Mrs. Ebe Cella Turner

Y

Mr. & Mrs. Jay Holmes
Dr. & Mrs. Richard Kunin
Mr. & Mrs. William Wallace Mein

Z

Mr. & Mrs. George Dyer
Mr. & Mrs. Lennart G. Erickson
Mr. & Mrs. Clem Whitaker, Jr.

THE '76 SEASON on Angel Records

MASSENET
THAIS
SILLS
MILNES
GEDDA
New Philharmonia
Orchestra
MAAZEL
SCLX-3832
(3 LPs & Tape)

WAGNER
DIE WALKURE
THE RING OF THE NIBELUNG PART II
Martha Mödl, Ferdinand Franz, Elsa Cavelti
Hilde Konetzni, Wolfgang Windgassen
Gottlob Frick
Orchestra of Radio Italiana (RAI), Rome
WILHELM FURTWÄNGLER
IE-6077
(5 LPs, Seraphim)

Verdi
La Forza del Destino
Marika Rokk
Clark Bonnell
Piero Chiarelli
Eleanora D'amico
Eugenio Kabanov
Gerrit Ewan
Gerrit Ewan
Gerrit Ewan
Ludovico Gardelli
SOL-3765
(4 LPs & Tape)
Highlights: S-36828

PUCCHINI
TOSCA
CALLAS
BERGONZI
GOBBI
PRETTE
SBL-3655 (2 LPs)
Highlights: S-36326
(LP & Tapes)

ROSSINI
THE BARBER OF SEVILLE
SILLS, MILNES, GEDDA
CAPECCI/BARBIERI
London Symphony Orchestra
LEVINE
SCLX-3761
(3 LPs & Tape)
Highlights: S-37237
(LP & Tape)

Mascagni
CAVALLERIA RUSTICANA
De Los Angeles Corelli
Sereni - Lazzarini
Rome Opera Orchestra & Chorus
Santini
SBL-3632
(2 LPs)

Angel
At Your Favorite
Record Stores
In The Bay Area

Bus Service

Many Opera goers who live in the northern section of San Francisco are regular patrons of the Municipal Railway's special "Opera Bus".

This bus is added to Muni's north-bound 47 Line following all evening performances of the Opera, Symphony, Ballet and other major events. The service is also provided for all Saturday and Sunday matinees.

Look for this bus, marked "47 Special", after each performance in the north-bound bus zone at Van Ness Avenue and Grove Street — across Van Ness from the Opera House.

Its route is as follows:

North on Van Ness to Chestnut, then left to Divisadero where it turns left to Union. It continues on Union over Russian Hill to Columbus, then left to Powell—then right to the end of the line at North Point.

Taxi Service

At all Opera performances, an attendant will be stationed at the taxi entrance of the Opera House, and persons wishing a taxi after the performance are requested to so advise the attendant upon their arrival. Shortly after the start of the performance, the attendant will telephone the dispatcher and inform him of the total number of taxis requested. Although the Opera Association cannot guarantee that a taxi will be available for each patron requesting one, we believe this procedure will help to improve post-performance taxi service for our patrons.

FIRE NOTICE: There are sufficient exits in this building to accommodate the entire audience. The exit indicated by the lighted "Exit" sign nearest your seat is the shortest route to the street. In case of fire please do not run—walk through that exit.

For lost and found information inquire at check room No. 3 or call (415) 621-6600, 8 a.m. to 4:30 p.m.

Opera Glasses

Opera glasses are available for rent in the lobby.

Please note that no cameras or tape recorders are permitted in the Opera House.

The War Memorial Opera House

Owned and operated by the City and County of San Francisco through the Board of Trustees of the War Memorial

Honorable GEORGE R. MOSCONE
Mayor, City and County of San Francisco

TRUSTEES

George T. Davis <i>President</i>	Philip S. Boone <i>Vice President</i>
Mrs. Angelina G. Alioto Fred Campagnoli	Mrs. Walter A. Haas Prentis C. Hale
Mrs. Joseph D. Cuneo A. Adrian Gruhn George Gund	Gregory A. Harrison Sam K. Harrison
Donald J. Michalske <i>Managing Director</i>	Stephen E. Dykes <i>Executive Secretary and Assistant Managing Director</i>

Friends of the War Memorial

Mrs. Joseph D. Cuneo,
Acting President

Mrs. Rudolph Driscoll

Mrs. Edgar Osgood

Mrs. Lyman Casey

Mrs. John Renshaw

Mrs. Charles M. Quarré

Mrs. Richard Walker

Mrs. John Ward Mailliard III

Mrs. Jean McClatchy

Mr. Whitney Warren

Mr. Bradford Walker

Mr. Innis Bromfield

For the safety and comfort of our audience all parcels, backpacks, luggage, etc., must be checked at the Opera House cloakrooms.

Hot buffet service in lower level one hour prior to curtain time.

Refreshments in the box tier on mezzanine floor, grand tier and dress circle during all performances.

Children of any age attending a performance must have a ticket.

Opera management reserves the right to remove any patron creating a disturbance.

Guarantor Members

The San Francisco Opera Association's Guarantor Program is a means by which subscribers pledge support to help cover the annual operating deficit of San Francisco Opera. Separate from the Opera Fund Drive, this giving program applies to prime Orchestra and Grand Tier seats on evening performances and to Box Seats on all series. We gratefully acknowledge the generous and devoted support of these important members of the opera family, as listed below.

REGULAR SERIES

Neal Aberman
Mrs. Agnes Albert
Col. Janice Albert
Mrs. Angelina G. Alioto
Estelle C. Allegrini
Mr. and Mrs. R. D. Allen
Mrs. Ernest O. Anders
Mr. and Mrs. Ross Anderson
Mr. and Mrs. Adolphus
Andrews, Jr.
Mr. and Mrs. Laurence
Andrews
Mr. and Mrs. Philip H.
Angell, Jr.
Val Arnold
Mrs. Henry Arrighi
Mr. and Mrs. Walter M. Baird
Mr. and Mrs. Edgar Baker
Dr. and Mrs. Shirley H. Baron
Mr. and Mrs. Irving Bartel
Mrs. Gloria Fischel Baruh
Mr. and Mrs. Richard M.
Bastoni
Mr. and Mrs. Alfred X. Baxter
Mrs. William Bayless
Mr. and Mrs. Joachim Bechtle
Mrs. Earl C. Behrens
Mr. and Mrs. Melvin Belli
Mr. and Mrs. G. Gordon Bellis
Mr. and Mrs. Ernest Benesch
John Kier Bennett
Mrs. G. Grace Benoist
Mrs. Walter H. Bentley
Mrs. Dirkan M. Berberian
Dr. Adolphus Berger
Eugene M. Berger
Marsha Berger
Alfred Jacob Berglund
Mr. and Mrs. F. Bruce Bernhard
Mrs. Newton Bissinger*
Mr. Clementjames Blaha
Dr. and Mrs. Stewart P. Blake
Mr. and Mrs. Fred Bloch
Robert and Joan Blum
Mr. and Mrs. Joseph
Blumenfeld
Barry B. Boideman
Mr. and Mrs. Philip S. Boone
Mr. and Mrs. D. Power
Boothe, Jr.
George M. Bowles
Mr. and Mrs. Henry M. Bowles
Mr. and Mrs. A. H. Brawner
Mr. and Mrs. John Norton
Breedon
Mr. and Mrs. Ernest R.
Bridgwater
Mrs. John Brooke
Mr. and Mrs. Valentine
Brookes
Mrs. Ralph Browne
Mr. and Mrs. Walter J. Browne
Mrs. E. E. Brownell
Mrs. Ellen Hindes Bruck
Mr. and Mrs. Carleton F. Bryan
Mr. and Mrs. John M. Bryan
Hildegard Christannia
Buckette
Mr. and Mrs. Richard I.
Buckwalter
Mr. and Mrs. John S. Burd
Mrs. Elliot Burstein
Julia W. Butler
Mr. and Mrs. Edgar L. Buttner
*Deceased

Mr. and Mrs. Robert W. Cahill
J. Archibald Calhoun
Mr. and Mrs. William
Cameron
Harry F. Camp
Mrs. John D. Campbell
Canamex Commodity Corp.
Mr. and Mrs. Philip D.
Cancellier
Mr. and Mrs. Burlington
Carlisle
Mr. and Mrs. Francis Carroll
Mr. and Mrs. Henry Cartan
Dr. and Mrs. Stephen K.
Carter
Mr. and Mrs. John B. Cella, II
Mr. and Mrs. Selah
Chamberlain, Jr.
Mr. and Mrs. Sheldon F.
Chanes
Chartered Bank of London
Mrs. Dunya Chernenko
Mr. and Mrs. Arnold C.
Childhouse
Mr. and Mrs. Marquis W.
Childs
Mario J. Ciampi
Frank T. and Ruth M. Cisek
Leon Wilson Clark, M. D.
Mr. and Mrs. Ralph L. Coffman
Alvin C. Cohen
Elizabeth L. Colton
Mr. and Mrs. D. Stephen
Coney
Mrs. Philip Conley
Mr. and Mrs. Ransom M. Cook
Mr. and Mrs. Richard P.
Cooley
Mr. and Mrs. O. E. Cooper
Dr. Robert N. Corfman
Mr. and Mrs. Warren J.
Coughlin
Mr. and Mrs. Malcolm Cravens
Kathryn and Bing Crosby
Mr. and Mrs. Thomas B.
Crowley
Mr. and Mrs. Daniel J. Cullen
Mr. and Mrs. Thomas Dahl
Mr. and Mrs. Forrest B.
Davidson
Mr. and Mrs. D. Douglas
Davies
Mrs. Ralph K. Davies
George W. Davis
Mrs. Genevieve de Dampierre
Ernest de la Ossa
Richard de Latour
Deer Creek Ranch
Mrs. Andre de Limur
Mr. and Mrs. Walter A.
de Martini
Mr. and Mrs. Reid W. Dennis
Mr. and Mrs. Robert E. Dettner
Mr. and Mrs. Kenneth J.
Detwiler
Mr. and Mrs. Harry de Wildt
Mr. and Mrs. Robert
Di Giorgio
Mr. and Mrs. John R. Dodds
Mr. and Mrs. Dewey Donnell
Nancy E. Donnell
Ann M. Draper
Ricardo Duenas T.
Mrs. James Durkin
James E. Durkin

Mrs. Betty Hinsdale Dwyer
Thomas Muir Dye
Mr. and Mrs. George Carter
Dyer
Mr. and Mrs. Frederick J. Early
Mr. and Mrs. Marriner S.
Eccles
Mr. and Mrs. Philip S.
Ehrlich, Jr.
Alexis L. Ehrman, Jr.
Mr. and Mrs. Theodore
Ellington
Mr. and Mrs. Duncan Elliott
Olive English
Dr. and Mrs. Wayne L.
Erdbrink
Mr. and Mrs. Lennart G.
Erickson
Mr. and Mrs. Richard Ernst
Mr. and Mrs. Milton H.
Esberg, Jr.
Mrs. Inez P. Ettleson
Mrs. Louis Ets-Hokin
Mr. and Mrs. Lee Ettelson
Henry Evers
Dr. and Mrs. Balhard G. Falk
Mr. and Mrs. James A. Felchin
Mr. and Mrs. A. Barlow
Ferguson
Mr. and Mrs. Charles D. Field
George H. Fitch
Mrs. Mortimer Fleishhacker
John L. Flynn
Robert M. Flynn
Mr. and Mrs. Benjamin N.
Follett
Mr. and Mrs. R. Gwin Follis
Dr. and Mrs. John D. Forbes
Mr. and Mrs. Angelo G.
Fornaciari
Michael Frenzell-Forrest
Mr. and Mrs. James D.
Forward, Jr.
Robert O. Fournier
Mr. and Mrs. James G.
Freeman
Mr. and Mrs. Harold R.
Freeman
Dr. and Mrs. M. Wallace
Friedman
Mr. and Mrs. Gerardo Fuentes
Alfred J. Gagnon
Mr. and Mrs. Nicholas
Gannam
Dr. Alexander N. Gansa
Claude L. Ganz
Robert K. Gardner
Steven H. Gavin, M. D.
Kathryn Gehrels
Dr. Frank Gerbode
Mr. and Mrs. Stanley B. Gerdes
Mr. and Mrs. Gordon P. Getty
Maurice Gibson
Mr. and Mrs. William W.
Godward
Mrs. Maurice L. Goldman, Sr.
Mrs. Rose L. Goldstein
Booth B. Goodman, Jr.
Reeve Gould
Mr. and Mrs. Adolphus E.
Graupner, Jr.
Dr. and Mrs. Gerald H. Gray
Mr. and Mrs. Edward M.
Griffith
Dr. and Mrs. Philip Grossi

Mr. and Mrs. A. Adrian Gruhn
Mr. and Mrs. Richard J.
Guggenheim
Dr. and Mrs. Howard Gurevitz
Mr. and Mrs. Edward W.
Gwinner
Mr. and Mrs. Walter A.
Haas, Sr.
Mr. and Mrs. George N.
Hale, Jr.
Mr. and Mrs. Marshal Hale, Jr.
Mr. and Mrs. Newton J. Hale
Mr. and Mrs. Prentis Cobb
Hale
David W. Hall
Mr. and Mrs. Richard C. Ham
Mr. and Mrs. William
Hamm, III
Dr. and Mrs. Warren Hansen
Mr. and Mrs. John C. Harley
Mrs. Charles Leonard Harney
Dr. and Mrs. David O.
Harrington
Dr. and Mrs. Joseph Harvey
Harris
Mr. and Mrs. L. W. Harris, Jr.
Mr. and Mrs. Robert C. Harris
Mr. and Mrs. Theodore Harris
Mrs. Edward T. Harrison
Mrs. I. P. Hartman
Mrs. Carlton W. Hartness
Mr. and Mrs. Harry Hastings
Horace O. Hayes
Elwood M. Haynes
Mrs. Easton G. Hecker
Mr. and Mrs. Jere N. Helfat
Mr. and Mrs. Robert D. Heller
Mrs. F. J. Hellman
Mr. and Mrs. I. W. Hellman
Robert E. Henderson
Mr. and Mrs. William E.
Henley
Mrs. Griffith Henshaw
Mrs. Thomas M. R. Herron
Mr. and Mrs. W. R. Hewlett
Diane Hickingbotham
Ellen Hill
Mr. and Mrs. Henry Hill
Austin E. Hills
Mr. and Mrs. Leslie W. Hills
Mr. and Mrs. Reuben W.
Hills, III
Dr. and Mrs. Frank
Hinman, Jr.
Mr. and Mrs. Charles S. Hobbs
Mr. and Mrs. Peter M.
Holbrook
Dr. and Mrs. James K.
Hollister
Leo E. Hollister
Mr. and Mrs. Jay Holmes
Mr. and Mrs. Douglas G. Holt
Mr. and Mrs. William Knox
Holt
Mr. and Mrs. Leonard G.
Homann
Mr. and Mrs. Shirley D.
Hopper
John T. Hornung
Mr. and Mrs. Jack H. How
Patricia M. Howe
Mr. and Mrs. Thomas Carr
Howe
Mr. and Mrs. Fdwin E.
Huddleson, Jr.
Fred G. Hudson, M. D.

Renée Helga Howie's
fall fantasy
with the charisma
of San Francisco.

Helga
Howie

Helga Howie, 140 Maiden Lane, San Francisco (415) 956-5450



Hear the Knabe special singing tone

Since 1837, when Knabe developed the balanced-tension scale, there has been one piano capable of matching the tonal clarity and brilliance of the world's great singers.

This special "singing tone" of the Knabe piano has made it the official choice of the San Francisco Opera and the Metropolitan Opera.

The Knabe is a piano equally at home in the concert hall, the studio, and your living room. Let it sing for you.





Knabe

For free color literature, write Knabe, Division of Aeolian Corporation, East Rochester, New York 14445

Gerald Huebner
David S. Hugle
Mr. and Mrs. Jaquelin H. Hume
Mrs. E. N. W. Hunter
Mrs. William N. L. Hutchinson
William N. L. Hutchinson, Jr.
Mr. and Mrs. Marion T. Hvidt
Mr. and Mrs. Bruce W. Hyman
P. Thomas Ibelli
Mr. and Mrs. G. William Jamieson
Mrs. Donald I. Janin
J. Roger Jobson
Mr. and Mrs. Franklin P. Johnson, Jr.
John R. Johnson
Mr. and Mrs. Reverdy Johnson
Walter S. Johnson
Mrs. Allen H. Jones
Mrs. Em Eccles Jones
Mrs. Robert Metcalf Jones
Mrs. Kenyon Joyce
Mr. and Mrs. Wallace L. Kaapcke
Mr. and Mrs. Edgar F. Kaiser
Col. and Mrs. Robert V. Kane
Maureen P. Kelley
Mrs. Charles Kendrick*
Mrs. Gerald D. Kennedy
Esther and Harlan Kessel
Michael N. Khourie
Mr. and Mrs. John R. Kiely
Mr. and Mrs. Jerold C. Kindred
Woodward Kingman
Mr. and Mrs. Francis R. Kirkham
Mr. and Mrs. James F. Kirkham
Mr. and Mrs. Gorham B. Knowles
Mr. and Mrs. John C. Koepke
Mr. and Mrs. Harold E. Koerber
Mr. and Mrs. Theodore A. Kolb
Elsa R. Korbel
Mr. and Mrs. Daniel E. Koshland
Mr. and Mrs. Robert J. Koshland
Mr. and Mrs. LeRoy F. Krusi
LeRoy H. Krusi, Jr.
Jaroslav V. Kubes
Donald D. Kuhlke
Dr. and Mrs. Richard Kunin
Mr. and Mrs. Charles S. LaFollette
Mrs. Linda Noe Laine
Mrs. Peter C. Lambert
Mr. and Mrs. Scott C. Lambert
Mr. and Mrs. Vernon N. Lambertsen
Mr. and Mrs. William Brooke Land
Shirle A. Lange
Harold A. Leader, Jr., M. D.
Major General and Mrs. O. A. Leahy
Mrs. John A. Lesoine
Mrs. Estelle F. Levine
Max P. Levine, M. D.
Robert A. Levy
Mrs. Patricia Wright Lewis
Mrs. Rudolph A. Light
The Light Opera
John G. Lilienthal
C. Maya Lit
Mr. and Mrs. Edmund W. Littlefield
George S. Livermore
Lawrence Livingston
Mr. and Mrs. John S. Logan
Mrs. Gordon Lovegrove
Olga S. Lucas
Mr. and Mrs. James J. Ludwig

Mr. and Mrs. Marcus Lummus
 Mr. and Mrs. Carl Lundstrom
 Prof. Joseph F. Lupino
 Mrs. Carlos J. Maas
 Mr. and Mrs. Graeme K. MacDonald
 Mr. and Mrs. Edmund MacDonald
 Mr. and Mrs. Leslie G. MacGowan
 Mr. and Mrs. John B. Mackinlay
 Mr. and Mrs. Michael MacPherson
 Peter Macris
 Dr. and Mrs. Thomas Madland
 Mr. and Mrs. John H. Madonne
 Uffe Juhl Madsen
 Cyril Magnin
 Mr. and Mrs. S. E. Mahy
 Mr. and Mrs. John Ward Mailliard, III
 Mr. and Mrs. George M. Malti
 Mr. and Mrs. Victor L. Marcus
 Mr. and Mrs. George Magar Mardikian
 Mr. and Mrs. Angelo Marino
 Dr. J. Peter Mark
 Mr. and Mrs. Francis N. Marshall
 Phillip E. Martin
 Roger M. Martin
 Charles E. Mather
 Joe Mathis
 Mrs. Albert C. Mattei
 Lucie M. Matzley
 Joseph Mauritzen, M. D.
 Mr. and Mrs. William D. Maus, Jr.
 Mrs. James W. McAlister
 James W. McClary
 H. Clifford McCollum, III
 Mrs. Ernest O. McCormick
 Joyce McDowell
 Mr. and Mrs. Garret McEnerney
 Mrs. Felix McGinnis
 Anna M. McHargue, M. D.
 Mr. and Mrs. John R. McKean
 Mr. and Mrs. James A. McKellar
 Mr. and Mrs. J. R. McMicking
 Mrs. William M. McMillan
 The Family of Mr. and Mrs. George P. McNear
 Mr. and Mrs. James K. McWilliams
 Mr. and Mrs. Edgar N. Meakin
 Mr. and Mrs. William Wallace Mein
 Mr. and Mrs. Edwin J. Mejia
 Mr. and Mrs. John F. Merriam
 Robert Messick
 Mr. and Mrs. John R. Metcalf
 Mr. and Mrs. Lawrence V. Metcalf
 Dr. and Mrs. Daniel W. Meub
 Mrs. Wilson Meyer
 Alan S. Michaels
 Mr. and Mrs. E. Homer Miller
 Mr. and Mrs. Otto N. Miller
 Mrs. Paul A. Miller
 Mr. and Mrs. Richard K. Miller
 Mr. and Mrs. Robert Folger Miller
 Mrs. Robert Watt Miller
 Stanley E. Miller
 J. F. Minnis, Jr.
 Mr. and Mrs. Milton Molinari
 Mr. and Mrs. Arch Monson, Jr.
 Mrs. Kenneth Monteagle
 Mr. and Mrs. Joseph A. Moore, Jr.
 Stewart Morton

Sea the world at its very best with Royal Viking Line and Pan Am.

-  Thirty-one departures beginning Oct. 16, 1976 through 1977.
-  Each cruise features the magnificent all First Class sailing style of Royal Viking Line. Elegant white ships of Norwegian registry. And spirit. With outside staterooms for 94% of all passengers, superb cuisine, excellent service.
-  Every flight via Pan Am, the all-747 airline across the North Atlantic and the Pacific. America's airline to the world.
-  All First Class land arrangements by Bennett Tours Inc., with over 100 years of travel experience.

South Seas
 14 Departures
 28 to 42 days
 From \$3032

Europe
 10 Departures
 28 to 55 days
 From \$2853

Circle Pacific
 4 Departures
 40 to 61 days
 From \$4109

Around the World and Orient
 3 Departures
 31 to 65 days
 From \$3051

For complete information, ask your travel agent about Pan Am Holiday 530, or call Royal Viking Line at 800-227-4246, toll-free.



ROYAL VIKING LINE 

 PAN AM®

SIEMER & HAND, LTD.
 TRAVEL SERVICE

ONE EMBARCADERO CENTER
 SAN FRANCISCO, CALIFORNIA 94111
 TELEPHONE 788-7186

Louis Muchy
 Mrs. Harriet K. Munguia
 Dr. and Mrs. Harold C. Murphree
 Jane Murray
 Dr. and Mrs. Anton C. Musladin
 E. M. Nagel
 Mrs. Charles Neal
 Mr. and Mrs. Kelvin K. Neil
 Dr. and Mrs. Thomas S. Nelsen
 Clarence E. Nelson
 Dr. and Mrs. Charles A. Noble, Jr.
 Charles E. Noble
 Mr. and Mrs. Allen L. Norris
 Dr. Florence R. Oaks
 Mrs. Ernest L. Offen
 Rev. William T. O'Keefe
 Mary Ann Okleson
 Mr. and Mrs. Jon Older
 Mrs. Alfred J. Olmo
 Dr. and Mrs. A. C. Olshen
 Oroweat Foods Company
 Mr. and Mrs. John C. Opperman
 Judge and Mrs. William H. Orrick, Jr.
 Alberto R. Orsini
 Mr. and Mrs. George J. Otto
 Mr. and Mrs. John R. Page
 Dr. and Mrs. Frank R. Passantino
 Mr. and Mrs. Donald Patterson
 Mary W. Patterson

Mr. and Mrs. Fred Pavlow
 Dr. Timothy A. Pedley
 Michael Pescetta
 Dr. John Peschau
 Mrs. Lester S. Peterson
 Mr. and Mrs. Louis Petri
 Jefferson E. Peyser
 William S. Picher
 Louis I. Piggott, Jr.
 Mr. and Mrs. Milton Pilhashy
 Michel Pisani
 Mr. and Mrs. Harold D. Pischel
 Walter Plunkett
 Mr. and Mrs. George A. Pope
 J. Lemoyne Porter
 Christopher J. Price
 Mrs. Donald N. Pritzker
 Dr. Roger Pyle
 Mildred J. Quinby
 Dr. and Mrs. H. E. Raitano
 Filomena Maria Ranuio
 Mrs. Vivienne Raven
 Mr. and Mrs. Donald N. Ravitch
 Robert F. Refvem
 Mr. and Mrs. Robert S. Reis
 Mr. and Mrs. John P. Renshaw
 Ms. Alice S. Resseguie
 E. Jerome Richards
 Dina and Robert L. Richards
 James D. Robertson
 Dr. and Mrs. Patrick Robertson
 Mr. and Mrs. Roy B. Robinette
 Mrs. Henry Wells Robinson
 Mr. and Mrs. Peter Rocchia

Mr. and Mrs. Ralph J. Roesling
 Dr. and Mrs. Ernest S. Rogers
 Mr. and Mrs. John G. Rogers
 Mrs. Nathan Rogers
 Mr. and Mrs. Ralph Romney
 Mrs. Leon L. Roos
 Dr. and Mrs. Hugh Rose, Jr.
 Mr. and Mrs. John N. Rosekrans, Jr.
 Mr. and Mrs. Millard Rosenblatt
 Harriet Ross
 Mrs. William P. Roth
 Dr. and Mrs. Leonard Rubinger
 Mrs. Madeleine Haas Russell
 Mrs. C. R. St. Aubyn
 Mr. and Mrs. Bertram Sampson
 Dr. and Mrs. John J. Sampson
 Dr. and Mrs. Bruce J. Sams, Jr.
 Benjamin T. Sanders
 Mr. and Mrs. Charles R. Sargent
 Mr. and Mrs. Alfred B. Saroni, Jr.
 Louis Saroni, II
 Dr. William Sawyer
 Mrs. Walter Schilling
 Mr. and Mrs. George B. Schirmer
 Frederick Schlosser
 Judge and Mrs. Robert H. Schnacke
 Mr. and Mrs. F. Karl Schoenborn
 Sifrid Schoenfelder
 Mrs. Jacob Gould Schurman, III
 Mr. and Mrs. Karl F. Schuster
 Mr. and Mrs. Edward W. Scripps
 Mrs. Martin J. Seid
 Mr. and Mrs. Francis Seidler
 Mr. and Mrs. Adolph K. Seiler
 Mr. and Mrs. Edwin A. Seipp, Jr.
 Jack Seitchik
 Mrs. Robert Seller
 Mrs. M. J. Senderman
 Mrs. A. Setrakian
 Charlotte W. Shaber
 Mrs. Floyd C. Shank
 Maryanna Gerbode Shaw
 Thomas L. Shelton
 Dr. A. Jess Shenson
 Dr. Ben Shenson
 Mrs. Louis Shenson
 Dr. and Mrs. William A. Sheppard
 Walter H. and Phyllis J. Shorenstein
 Mr. and Mrs. Roy L. Shurtleff
 Mr. and Mrs. Robert F. Shurtz
 Dr. and Mrs. Edward A. Sickles
 Dr. and Mrs. Henry L. Silvani
 Mr. and Mrs. Sol Silverman
 Mr. and Mrs. Ronald B. Simpkins
 Mr. and Mrs. Edgar Sinton
 Tance Johnson Sitton
 Mrs. Verne L. Skjonsby
 Beatrice B. Slater
 Mrs. Louis Sloss
 David R. Smith
 Mrs. Ferdinand Smith
 Russell G. Smith
 Virginia B. Smith
 Christian M. Soenksen
 Mr. and Mrs. William S. Solari, Jr.
 Ruth Freeman Solomon
 Mr. and Mrs. Allan E. Sommer
 Mrs. Peter S. Sommer
 Mrs. Muriel McKevitt Sonne
 Mrs. T. A. Soong
 Mrs. Huntley Soyster



Tenth Anniversary Season
 1976-1977 Season
 December 1, 1976 — May 22, 1977

Repertoire

Don Pasquale - Donizetti (new production)
 Susannah - Floyd (new production)
 The Marriage of Figaro - Mozart
 The Portuguese Inn - Cherubini
 all in English

Dr. Jay D. Sprenger
Mr. and Mrs. Kenneth M. Stamp
Mr. and Mrs. Alan R. Stein
Mr. and Mrs. Louis P. Steller
Dr. and Mrs. Lawrence Daniel Stern
Stanford Stevenson
L. R. Stoeven, III
Dr. and Mrs. E. Frederick Stolte
Daniel E. Stone
Mr. and Mrs. G. C. Stone
Mr. and Mrs. Norman C. Stone
Dwight V. Strong
Mr. and Mrs. Barry Stubbs
Mrs. Walter Sullivan, Sr.
Mr. and Mrs. Bert O. Summers
Boris Sutter
Madge H. Sutton
Benjamin H. Swig
Mr. and Mrs. Forrest Tancer
Mr. and Mrs. Augustus Taylor, Jr.
Carl Taylor
L. Jay Tenenbaum
Mr. and Mrs. Milton W. Terrill
Mr. and Mrs. Nicholas G. Thacher
Dade Thieriot
Robert A. Thompson
William R. Thompson
Mr. and Mrs. Francis W. Thorn
Neil Thrans
Charles A. Tice
Mr. and Mrs. H. Keith Tiedemann
Cecil G. Tilton
Mr. and Mrs. F. J. Thomas
Tilton
Cyril Tobin
Mr. and Mrs. Joseph Zook
Todd
Mr. and Mrs. Alfred T. Tomlinson
Donald M. Traeger, M. D.
Mr. and Mrs. Gardiner Trowbridge, II
Mrs. Nion R. Tucker
Mrs. Grover D. Turnbow
Mrs. Ebe Cella Turner
D. M. Underdown
Dr. and Mrs. John R. Upton
Dr. and Mrs. John Urquhart
H. A. Valenzuela
Mr. and Mrs. Frank Van Steenberg
Mr. and Mrs. George A. Vare, Jr.
Mrs. Alice B. Vincilione
Mr. and Mrs. Daniel G. Volkman, Jr.
Mr. and Mrs. Alexander Henry von Hafften
Charles von Loewenfeldt, Inc.
Mr. and Mrs. George Wagner
Bradford H. Walker
Mr. and Mrs. Brooks Walker
Mr. and Mrs. Brooks Walker, Jr.
Mr. and Mrs. Bruce Walker
Mr. and Mrs. Richard Walker
Mrs. Willis Walker
Mr. and Mrs. Edward B. Wallis
Arnold Ward
Whitney Warren
Mrs. Paul Wattis
Dr. and Mrs. Malcolm S. M. Watts
Mr. and Mrs. Norman V. Wechsler
Dr. and Mrs. Harry Weinstein
Mr. and Mrs. Edward P. Wells

Mrs. James M. Wells
Mrs. Charles F. Weyman
Mr. and Mrs. Rollin C. Wheeler
Mr. and Mrs. Clem Whitaker, Jr.
Mr. and Mrs. George B. White
Mrs. Brayton Wilbur
Thomas E. Williams
Glenn E. Willoughby, M. D.
R. E. Willson
Alfred S. Wilsey/Pat Montandon
Mrs. Dean Witter
Mrs. Jean C. Witter
Mrs. Casimir Jackson Wood
Mr. and Mrs. Frank M. Woods
J. L. Wrathall
Mr. and Mrs. J. Perry Yates
Ruth Zahn
Charles Zaninovich
Mr. and Mrs. Harold L. Zellerbach
Mrs. C. F. Zobel
Mr. and Mrs. Peter Zuber
Michael D. Zullo
David Zussman

GUARANTOR MEMBERS

(\$100 or more)

OTHER SERIES

Charles and Catherine Abbe
Dr. and Mrs. Francis W. Thorn
Neil Thrans
Charles A. Tice
Mr. and Mrs. H. Keith Tiedemann
Cecil G. Tilton
Mr. and Mrs. F. J. Thomas
Tilton
Cyril Tobin
Mr. and Mrs. Joseph Zook
Todd
Mr. and Mrs. Alfred T. Tomlinson
Donald M. Traeger, M. D.
Mr. and Mrs. Gardiner Trowbridge, II
Mrs. Nion R. Tucker
Mrs. Grover D. Turnbow
Mrs. Ebe Cella Turner
D. M. Underdown
Dr. and Mrs. John R. Upton
Dr. and Mrs. John Urquhart
H. A. Valenzuela
Mr. and Mrs. Frank Van Steenberg
Mr. and Mrs. George A. Vare, Jr.
Mrs. Alice B. Vincilione
Mr. and Mrs. Daniel G. Volkman, Jr.
Mr. and Mrs. Alexander Henry von Hafften
Charles von Loewenfeldt, Inc.
Mr. and Mrs. George Wagner
Bradford H. Walker
Mr. and Mrs. Brooks Walker
Mr. and Mrs. Brooks Walker, Jr.
Mr. and Mrs. Bruce Walker
Mr. and Mrs. Richard Walker
Mrs. Willis Walker
Mr. and Mrs. Edward B. Wallis
Arnold Ward
Whitney Warren
Mrs. Paul Wattis
Dr. and Mrs. Malcolm S. M. Watts
Mr. and Mrs. Norman V. Wechsler
Dr. and Mrs. Harry Weinstein
Mr. and Mrs. Edward P. Wells

Alton J. Bernhard
Dr. and Mrs. Jerome W. Bettman
Mr. and Mrs. Robert L. Bianco
Dr. Alfred D. Bicusnas
John W. Bissinger, Jr.
Ralph S. Blomberg
Burton S. Blumert
Dave and Diana Bohn
Mr. and Mrs. William L. Bolei
Richard R. Booth
Joan C. Borame
Mr. and Mrs. Dix Boring
Albert L. Boswell
Lial Bothwell
Dr. Albert Bowers
Mr. and Mrs. John L. Bradley
Mr. and Mrs. William T. Brantman
Dr. and Mrs. Henry Brean
Edward C. Brehm
Dr. John P. Briske
Dr. and Mrs. Mark J. Brockbank
Dr. William F. Bromm, III
Robert E. Brownell
Mrs. Starr Bruce
Mrs. H. C. Buckheim
Nora-Lee and Alfred C. Buckingham
Joseph Buckley
Edward R. Bunting
Mr. and Mrs. Theodore Burgess
James H. Burke
Margaret A. Burnett
Mr. and Mrs. Sumner Burrows
William Bush
George H. Cabaniss, Jr.
William P. Cagle, M. D.
Mr. and Mrs. Donald M. Cahen
Katherine Field Caldwell
California Arts Society
Dr. Mary E. Cantrell
Mrs. Kay F. Carpenter
Dr. Norman F. Carrigg
Frances Monet Carter
Mr. and Mrs. D. R. Casebolt
Mr. and Mrs. Robert G. Caughey
Rex G. Chase
David Cheifetz
Peter Chernik
Edward Chichura
Mr. and Mrs. J. Robert Christy
Ralph Cicurel
Leo J. Cipa
Mrs. Donald W. Cleary
B. Sherman Coffman
Dr. and Mrs. Nathan Cohen
Persis H. Coleman
Ella Collier
C. F. Collins
Helena Conant
Dr. Marcus A. Conant
Mrs. Gene Connell
Dr. and Mrs. Harold T. Conrad
Mr. and Mrs. Walter E. Conrad
Dr. and Mrs. Charles E. Cooper
Mrs. Robert S. Cooper
Anton Cortese
Darrell F. Corti
Dr. and Mrs. Richard H. Cote
Ernest L. Covington
William R. Crawford
Mr. and Mrs. Armand Croft
Mr. and Mrs. Edward L. Culin
Edith P. Cunningham
Mr. and Mrs. Garniss H. Curtis
Dr. and Mrs. Thaddeus Cwalina
Mr. and Mrs. Jay A. Darwin

Mr. and Mrs. Peter W. Davis
Dr. and Mrs. Herbert H. Dedo
Dr. and Mrs. Roy R. Deffebach
Ralph del Sarto
Mr. and Mrs. Heiko T. de Man
Dr. John J. Demas
Mr. and Mrs. George W. Deskin
Dr. and Mrs. William Dickerson
Frank S. Dietrich
J. P. Richards Dillingham
Mrs. Everett Dodd
Mrs. Gerald A. Dohrmann
Dr. Richard H. Dorsay
Dr. and Mrs. Thomas Drake
Sherwood Dudley
Elaine and Kenneth Dumas
Dr. and Mrs. Michael Dumas
Mrs. Cavalier Durney
Phillip L. Eaton
Mr. and Mrs. Christian Ebsen
Dr. and Mrs. Albert S. Edgerton
Peter Elkind
Chris Elliott
Anne M. Ellis
Mr. and Mrs. William H. Elsner
Richard Ensslin
Mr. and Mrs. Richard Ernst
Robert Eshleman
Mr. and Mrs. Henry Evans
Dr. and Mrs. Seymour M. Farber
Richard C. Farley
Wesley J. Fastiff
Mr. and Mrs. Thomas K. Fawcett
Mr. and Mrs. Andrew E. Feiner
Ronald L. Fenolio
David Field
John H. Finger
Prof. and Mrs. Hugo B. Fischer
Warren D. Fishburn, Jr.
Robert S. Fisher
Wayne H. and Theo F. Fisher
Mrs. Meader Fletcher
Dr. and Mrs. William W. Foote
Richard N. Frahm
Mr. and Mrs. C. K. Poe Fratt
Gerald J. Frederick
Szebelski L. Freeman, Jr.
Dr. Allen B. Freitag
Norman F. Friedman
Dean E. Friedrich
Mr. and Mrs. Alfred Fromm
Furness Interocean Corp.
Rev. James P. Gaffey
Michael Theodore Gallagher
Mr. and Mrs. Ralph J. Gampell
Jack and Carroll Gardner
Dr. and Mrs. Jay Gershow
Mr. and Mrs. Charles Gillespie
Mr. and Mrs. E. S. Gillette, Jr.
Mrs. Pauline E. Gilmore
Dr. and Mrs. James M. Glick
Mr. and Mrs. William W. Godward
Mr. and Mrs. Burton D. Goldstein
David B. Goodstein
Dr. and Mrs. Robert B. Gordon
Richard N. Gould
Mr. and Mrs. Greig A. Gowdy
Mrs. William Gray
Harold Green
Ronnie C. Green
Mr. and Mrs. G. J. Grieve
Mr. and Mrs. Douglas W. Grigg

Marvin M. Grove
 Guardian Packaging Corp.
 Michael R. Gumbmann
 Richard B. Gump
 Lawrence Eric Gustafson
 Joseph P. Gutstadt
 Marie and Charles K. Guttas
 Dr. H. Clark Hale
 Dr. and Mrs. Walter B. Hall
 Joan Ayres Hamren
 Louis and Sandra Handler
 Patricia Hanson
 Betty-Lou Harmon
 Dr. M. Robert Harris
 Dr. R. S. Harrison, Jr.
 Mr. and Mrs. Ernest E. Haskin
 Dr. and Mrs. John E. Hasson
 Mr. and Mrs. Milan Haven
 General and Mrs. Thomas J. Hayes, III
 Margaret F. Hayes
 Mr. and Mrs. James C. Hazard
 Mr. and Mrs. Wayne H. Heldt
 Alfred E. Heller
 Mr. and Mrs. Thomas Henderson
 Mr. and Mrs. Whalen K. Hickey
 Mr. and Mrs. Thomas High
 Mr. and Mrs. G. L. Higuera
 Mrs. Norman L. Hill
 Robert B. Hill
 Bernard W. and Carol W. Hindman
 Dr. Carter S. Hjelte
 Mrs. Edward Hohfeld
 Mr. and Mrs. Louis Honig
 Dr. and Mrs. Eugene S. Hopp
 Harold H. Hopper, M. D.
 Raymond D. Houck
 Howard, Prim, Rice,
 Nemerovsky, Canady & Pollak
 Drs. Wolfgang and Kerstin Huber
 Dr. and Mrs. T. Wesley Hunter
 Dr. Paul J. Isakson
 Dr. George Arthur Jack
 Mr. and Mrs. William P. Jaeger, Jr.
 Dr. and Mrs. John P. Jahn
 S. Perry Jenkins
 Harold I. Johnson
 Howard P. Johnson
 H. R. Johnson
 Mr. and Mrs. Robert G. Johnson
 Mrs. Robert Malcolm Johnson
 Mr. and Mrs. Proctor P. Jones
 Thomas L. Jordan, Jr.
 Eleanor Jue
 Mr. and Mrs. William V. Kane
 Otto Frederick Kanitz
 Mr. and Mrs. Richard M. Kaplan
 Sherry and Dick Karrenbrock
 Frances Lee Kaufman
 Kelso, Hunt, Ashford & Ludwig
 Mr. and Mrs. Charles W. Kenady
 Raymond S. Kimbell
 Gibson Kingren
 Mrs. Winifred E. Kistler
 KKHI AM/FM
 Mr. and Mrs. A. E. Knowles
 Thomas and Kathryn Koehler
 Mr. and Mrs. Kenneth S. Kojima
 Dr. and Mrs. Herbert J. Konkoff
 Leonard Koppett
 Mr. and Mrs. Bernard M. Kramer
 Mr. and Mrs. L. J. Kusber, Jr.
 Thomas M. Lacey
 Presley Lancaster
 Mrs. N. Scott Lapham
 Grant A. Larsen
 Dr. and Mrs. Paul E. Lavoie
 Norman and Mary Ann Layne
 Dr. and Mrs. Chauncey D. Leake
 Dr. Richard E. LeBlond, Jr.
 Mr. and Mrs. Norman Leonard
 Douglas Leong
 Mr. and Mrs. Leon Lerman
 Mrs. Mary S. Levine
 John C. Lewis
 Dr. D. A. Liddicoat
 Robert D. Lilienthal
 Betty Y. Lin
 Karen Lindfors
 P. J. C. Lindfors
 J. A. Littleton
 Mr. and Mrs. Carl Livingston
 Carol B. Lodato
 Peter R. Loeb
 W. Robert Lomax, Jr.
 John R. Lonergan
 James P. Lovegren
 Carl D. Lovotti
 Mr. and Mrs. Anatole Taras Lubovich
 Dr. and Mrs. Karl Ludwig
 Dr. and Mrs. Irving R. Lunt, Jr.
 Harry W. Lutrin, M. D.
 C. Keith Lyde
 Gilbert C. Lyle
 Dr. and Mrs. Thomas G. Lyons
 Thomas W. Malloy
 Dr. Jack F. Mangum
 E. R. Manwell
 Marine Chartering Co., Inc.
 Mr. and Mrs. Michael Marston
 Mr. and Mrs. Joseph Martin, Jr.
 Mary Martin
 W. Scott Martin
 Mr. and Mrs. Stephen J. Martin
 Mr. and Mrs. Theodore A. Martin
 Col. and Mrs. Ralph Martindale
 Jack A. Martinelli
 Linda and Barry Martinez
 Mr. and Mrs. George C. Martinez
 Dr. and Mrs. M. Lewis Mason
 Dr. and Mrs. Jacob L. Mathis
 Mr. and Mrs. John N. McBaine
 Mr. and Mrs. Turner H. McBaine
 Lucy Kelly McCabe
 Dr. and Mrs. Kenneth R. McCormack
 Mr. and Mrs. Robert H. McCrary
 Mrs. Davis McEntire
 Donald C. McGee
 Dr. Teresa McGovern
 Michael C. McGuckin
 Mr. and Mrs. John C. McGuire
 Mr. and Mrs. G. V. McKeever, Jr.
 James B. McKinney
 Mrs. E. Johnson McRae
 Mr. and Mrs. J. Alec Merriam
 Mrs. Gregor C. Merrill
 J. Lee Mershon
 Dr. William P. Meseroll
 Robert Messick
 Dr. Vincent P. Messina
 Mr. and Mrs. A. C. Meyer, Jr.
 Mr. and Mrs. Ernest W. Meyer
 Mr. and Mrs. Otto E. Meyer
 Mr. and Mrs. Allan P. Miller
 Daniel C. Miller
 Hugh B. and Helen Miller
 Mrs. Robert Watt Miller
 John L. Milton
 Mr. and Mrs. Bruce T. Mitchell
 Mr. and Mrs. Osmond Molarsky
 Montage, Ltd.
 Georgia M. Moody
 Graham B. Moody, Jr.
 Mr. and Mrs. Joseph G. Moore
 Dr. Richard Morehead
 Mr. and Mrs. Peter Morrison
 Mr. and Mrs. Darrell Mueller
 Paul and Roberta Mundie
 Mr. and Mrs. James Murad
 Mr. and Mrs. Daniel J. Murphy
 Keshavan and Gisela Nair
 Mrs. Anna Belle Neal
 Dr. and Mrs. Ernest Newbrun
 James W. Newell
 Col. and Mrs. C. W. Nicolary
 Mrs. Erich Nielsen
 Gerald V. Niesar
 Dr. and Mrs. Paul W. Nordquist
 Forbes Norris
 Mr. and Mrs. James L. O'Dea
 Mr. and Mrs. C. Y. Offutt, Jr.
 Donald L. Olsen
 Oscar E. Olson
 Joseph P. O'Neill
 Mrs. Ernst Ophuls
 Burt Orben
 Orrick, Herrington, Rowley & Sutcliffe
 Mr. and Mrs. William Randolph Oscarson
 Alton B. Otis, Jr.
 Joan Sartorius Ottey
 Sylvia Overholt
 Mr. and Mrs. F. Ward Paine
 Mr. and Mrs. Peter W. Palmer
 Judge and Mrs. George E. Paras
 Peter and Isabel Paret
 Edwin R. Parks
 Lawrence H. Parsons
 Mrs. Alex A. Payette
 Peter A. Pender
 Dr. and Mrs. Roland K. Perkins
 John D. Petuya
 Dr. and Mrs. Theodore Locke Phillips
 Michel Pisani
 Mr. and Mrs. Robert B. Pitts
 Paul and Helen Pocher
 Dr. Paul E. Poenisch
 Harry Pollard
 Dr. Stanford Pollock
 J. Ronald Powell
 Ralph L. and Myra D. Preston
 Mrs. Renate Radcliffe
 Michael Raddie
 Mr. and Mrs. Michael G. Rafton
 James G. Randall
 Dr. Kenneth Rashid
 Mr. and Mrs. Richard H. Rasmussen
 Dr. and Mrs. George T. Raust, Jr.
 Allen Reid
 Mr. and Mrs. William G. Rey
 William W. Rhoades
 Dr. Paul R. Rhodes
 Dr. and Mrs. Benjamin T. Richards
 Mr. and Mrs. Baxter K. Richardson
 Andrew M. Riolo
 Mr. and Mrs. Roger A. Ritchey
 Dr. Edward D. Robbins
 Alan Rockwell
 Sylvia Rohde
 Mr. and Mrs. Stanley Rosch
 Dr. and Mrs. Alan J. Rosenberg
 Mr. and Mrs. Barr Rosenberg
 J. A. Rosenthal
 Dr. and Mrs. Harry L. Roth
 John E. Ruden
 Joseph L. and Elisabeth Ruegg
 Mrs. Richard Salmon
 San Jose Opera Guild
 Sanwa Bank, Ltd.
 Ruth and Richard Sayre
 Mr. and Mrs. George B. Scheer
 Dr. and Mrs. Richard Schellinger
 Mr. and Mrs. Philip S. Schlein
 Kurt and Barbara Artson Schlesinger
 Leon H. Schmidt
 Dr. and Mrs. Thomas D. Schmitz
 Dr. B. J. Schreiner
 Royce H. Schulz
 E. Williard Schurz
 Murray A. Schutz
 Dr. and Mrs. Stanton G. Schwartz
 Thomas R. Schweitzer
 Mrs. Martin Seamster
 Grant A. Settlemer
 Patricia Arnold Sevison
 Mr. and Mrs. Marshall A. Shapiro
 Dr. and Mrs. Glenn E. Sheline
 Don N. Sheppard
 Dr. and Mrs. Edward E. Shev
 S. M. Shnider
 Dr. and Mrs. Mervyn Shoor
 Mr. and Mrs. Lawrence L. Shrader
 Dr. and Mrs. William J. Siegel
 Dr. and Mrs. Jon F. Sigurdson
 Paul C. Silva
 Dr. and Mrs. Charles Silver
 Marjory C. Simmons
 John E. Simon
 Mrs. Eleanor F. Sloss
 Mr. and Mrs. Frank H. Sloss
 Dr. Chandler S. Smith
 Mr. and Mrs. Mortimer Smith, III
 R. Randolph Smith
 Richard Neil Snyder
 Richard L. Sogg
 Stephen Lloyd Sorensen
 Drs. George and Nadia Sorokowski
 Margaret J. and John E. Sparks
 Mrs. Melba J. Sparks
 Mr. and Mrs. Leonard M. Sperry, Jr.
 Mrs. Victor B. Staadecker
 Robert M. Stafford
 Mr. and Mrs. William D. Stein
 Dr. Stuart Steinberg
 Mr. and Mrs. Robert Steiner
 Dr. and Mrs. Harold M. Sterling
 Harry and Elsie Stern
 Mr. and Mrs. Paul B. Stewart
 Mr. and Mrs. Robert J. Stewart
 Mr. and Mrs. Samuel B. Stewart
 Joseph A. Stockdale
 Mr. and Mrs. Kneeland E. Stone
 Frank D. Stout
 Dr. and Mrs. J. M. Stubblebine
 Lorenzo Sturkey
 Dr. and Mrs. Reuben Stutch
 Mr. and Mrs. Robert M. Sutton
 Stephen John Suzman
 Dr. and Mrs. Alan D. Swensen
 Donald S. Tayer

Fund Drive

Betty Jean Thomas
Harrison Thomson
Neil Thrans
Tiegel Manufacturing Co.
William J. Tikunoff
Dr. Kathleen Bell Unger
Michael J. Varn
Mr. and Mrs. Marco A. Vinella
Sophia Vlamis
Mr. and Mrs. L. G. Von
Schottenstein
Dr. Helen M. Wallace
Mr. and Mrs. Barry M. Wally
Mr. and Mrs. Robert H. Walter
Dr. Arthur W. Ward, Jr.
Beatrice S. Ward
Mr. and Mrs. Edmond C. Ward
Ann Waterman
Jacob I. Waxman
John and Erna Weeks
Dr. and Mrs. Miley B. Wesson
Mrs. R. Stacy White
Michael N. Wilkinson
Paul W. Wilkinson
Mr. and Mrs. Orris W. Willard
Mr. and Mrs. William H.
Williams
Charles R. Willis
Mr. and Mrs. Carl Witkovich
Dr. and Mrs. Bertram L.
Wolfsohn
Victor Wong
Patricia Woodward
Mrs. Gatis Yates
Dr. and Mrs. Paul F.
Youngdahl
Dr. and Mrs. V. P. Zarcone, Jr.
Mr. and Mrs. Clerin W.
Zumwalt

The San Francisco Opera Association sincerely appreciates the generosity of major contributors to its annual Opera Fund Drive. Listed below are those corporations, foundations, and individuals in the community who contributed to the fund drive from August 1, 1975 to September 28, 1976. Unfortunately, space does not permit us to list contributors of under \$500, to whom we also extend our thanks. In addition, many of those listed below and others have made major contributions to the Opera Association's five-year \$5 million Endowment Fund, begun in 1973. Without the ongoing support of all of our contributors, we could not continue to produce the quality of opera which ranks San Francisco Opera among the major national and international companies in the world today.

BUSINESS SUPPORT OF SAN FRANCISCO OPERA BUSINESS PATRONS \$5,000 AND OVER

Bank of America Foundation
Crown Zellerbach Foundation
Pacific Gas & Electric Company
Retail Dry Goods Association
The Jos. Schlitz Brewing
Company
Standard Oil Company of
California
Wells Fargo Bank

BUSINESS PATRONS \$2,500 — \$4,999

American Potato Company
Bechtel Corporation
Crocker National Bank
Fireman's Fund American
Foundation
Foremost-McKesson, Inc.
International Business
Machines Corporation
Kaiser Affiliated Companies
Pacific Lighting Corporation
Pacific Telephone & Telegraph
Corporation
Santa Fe Railway Foundation,
Inc.
Levi Strauss Foundation
Syntex Corporation
Teledyne Charitable Trust
Foundation
Transamerica Corporation
Mrs. Georgia M.
Worthington

BUSINESS BENEFACTORS \$1,000 — \$2,499

AMFAC Foundation
Arthur Anderson & Company
The Bank of California
British Petroleum Alaska
Del Monte Corporation
Di Giorgio Corporation
Fibreboard Foundation
Great Western Savings & Loan
Association
Shell Companies Foundation
Stauffer Chemical Company
Union Oil Company of
California Foundation
United California Bank
United States Steel
Corporation
Utah International, Inc.
Van Waters & Rogers

BUSINESS DONORS \$500 — \$999

The Adolph's Foundation
Bethlehem Steel Corporation
The Clorox Company
Coldwell Banker & Company
Dow Chemical USA
Haskins & Sells
Industrial Indemnity
Foundation
Marsh & McLennan, Inc.,
Foundation
McMicking & Co.
Metropolitan Life Insurance
Company
Peat, Marwick, Mitchell & Co.
Potlatch Corporation
Security Pacific National Bank
Sugar Drayage Company
United States Leasing
International, Inc.
Arthur Young & Company

MAJOR CONTRIBUTORS TO THE FUND DRIVE SUSTAINING PATRONS \$5,000 AND OVER

The Bothin Helping Fund
Malcolm Cravens Foundation
Louise M. Davies Foundation
Gamma Fisher Foundation
Mr. and Mrs. Wayne H. Fisher
The Ford Foundation
The Hearst Foundation
Mr. and Mrs. Gordon P. Getty
Mrs. W. J. Gray
George Lauder Greenway
Elise S. Haas
Mr. and Mrs. William H.
Hamm, III
The Holmes Foundation
The William G. Irwin Charity
Foundation
Mrs. Em Eccles Jones
Mr. and Mrs. Proctor P. Jones
Mr. and Mrs. Edgar F. Kaiser
Mr. and Mrs. Daniel E.
Koshland
Mrs. Rudolph A. Light
Mr. and Mrs. Edmund W.
Littlefield
The Louis R. Lurie Foundation
Cyril Magnin
Mr. and Mrs. Edgar N. Meakin
G. H. C. Meyer Family
Foundation
Mrs. Robert Watt Miller
Robert M. Moore

National Endowment for the
Arts
David and Lucile Packard
Foundation
James D. Robertson
San Francisco Foundation
The L. J. and Mary C. Skaggs
Foundation
Frank M. Tack
Whitney Warren
The Paul L. and Phyllis Wattis
Foundation
Cynthia Wood

PATRONS \$2,500 TO \$4,999

Mrs. Angelina G. Alioto
Mr. and Mrs. Henry Cartan
Mr. and Mrs. John B. Cella, II
Mr. and Mrs. Dewey Donnell
Mr. and Mrs. A. Adrian Gruhn
Mrs. Edward T. Harrison
William Randolph Hearst
Foundation
Mr. and Mrs. William Knox
Holt
Mr. and Mrs. Richard K. Miller
Arthur Rock
Mr. and Mrs. Edward W.
Scripps
Mrs. Dean Witter
Mrs. Georgia M. Worthington
Mrs. J. D. Zellerbach

BENEFACTORS \$1,000 — \$2,499

Mr. and Mrs. Adolphus
Andrews, Jr.
Mr. and Mrs. K. K. Bechtel
Mrs. G. Grace Benoist
Mrs. Walter Bentley
Mr. and Mrs. Joseph
Blumenfeld
Mr. and Mrs.* James Bodrero
Breeden
Robert and Alice Bridges
Foundation
Mrs. Starr Bruce
Mrs. Ellen Hinds Bruck
Mrs. Edith E. Bundy
Mrs. William Cameron
Mr. and Mrs. Burlington
Carlisle
Mr. and Mrs. A. W. Clausen
Columbia Foundation
Mrs. D. Stephen Coney
Mr. and Mrs. O. E. Cooper
*Deceased

Ticket Information

SAN FRANCISCO OPERA BOX OFFICE LOBBY, WAR MEMORIAL OPERA HOUSE: Van Ness at Grove, (415) 431-1210. 10 a.m. to 6 p.m. Monday through Saturday. 10 a.m. through first intermission on all performance days.

IMPORTANT NOTICE: The box office in the outer lobby of the Opera House will remain open through the first intermission of every performance. Tickets for remaining performances in the season may be purchased at this time.

Unused Tickets

Patrons who are unable to attend a performance may make a worthwhile contribution to the San Francisco Opera Association by returning their tickets to the Box Office or telephoning (415) 431-1210. Their value will be tax deductible for the subscriber. If tickets are re-sold, the proceeds will be used to benefit the San Francisco Opera.

Opera Museum

The 1976 exhibit in the opera museum, prepared in its entirety by the Archives for the Performing Arts, represents a detailed historical profile of the beginnings of opera in the city of San Francisco, tracing our art form up through the founding of San Francisco Opera.

Archives for the Performing Arts, which serves as a repository for invaluable collections pertaining to opera, dance, music and theater, is a non-profit, tax exempt corporation, with headquarters in the San Francisco Public Library, Presidio Branch. The museum display represents countless hours of research and preparation of visuals by Archives' director, Russell Hartley, and Judith Solomon, his assistant, with Lim M. Lai serving as overall consultant on the project.

The specific purpose for which Archives for the Performing Arts was formed was to collect, preserve, classify and exhibit all types of memorabilia pertaining to all the performing arts and to make the educational and historical material accessible to the general public on a continuing basis.

The opera museum, in the south foyer, box level, is open free of charge during all performances.

Mrs. Archibald Reid Dennis
Mr. and Mrs. Robert Di Giorgio
Dean B. Eggertsen Foundation
Eldorado Foundation
Mr. and Mrs. Richard J. Elkus
Mr. and Mrs. Lennart G. Erickson
Mr. and Mrs. Charles D. Field
Mr.* and Mrs. Mortimer Fleishhacker, Jr.
Mr. and Mrs. R. Gwin Follis
Mrs. Andrew A. Fraser
Mr. and Mrs. C. K. Poe Fratt
Mr. and Mrs. Alfred Fromm
The William G. Gilmore Foundation
Francis Goelet
Dr. Jean Haber Green
The Walter and Elise Haas Fund
Mr. and Mrs. Newton J. Hale
Mr. and Mrs. Prentiss Cobb Hale
David W. Hall
Mrs. Charles L. Harney
Mr. and Mrs. Robert C. Harris
Mrs. F. J. Hellman
Mr. and Mrs. I. W. Hellman
Mr. and Mrs. Reuben W. Hills, III
Mr. and Mrs. Jack H. How
Mr. and Mrs. Thomas Carr Howe
The Walter S. Johnson Foundation
Mrs. Elizabeth Keeler
Mrs. Charles Kendrick*
Mr. and Mrs. John R. Kiely
Mr. and Mrs. Gorham Knowles
Mr. and Mrs. Frederick O. Koenig
Mrs. Jesse Koshland
Mrs. Charles B. Kuhn
Mr. and Mrs. Vernon N. Lambertsen
Edmund Wattis Littlefield Foundation
Mrs. Jeanne Magnin
Mr. and Mrs. Robert A. Magowan
Mr. and Mrs. Victor L. Marcus
Mrs. James W. McAlister
The Atholl McBean Foundation
Mrs. Gregor C. Merrill
Mr. and Mrs. John R. Metcalf
Mrs. Marian M. Miller
Otto N. Miller
Paul A. Miller
Mrs. Charles Munn
Judge and Mrs. William H. Orrick, Jr.
Mr. and Mrs. George J. Otto
Mr. and Mrs. Louis Petri
Mr. and Mrs. George A. Pope
Mrs. Stanley Powell
Mr. and Mrs. Spelman Prentice
Mrs. Robert H. Scanlon
Mr. and Mrs. F. Karl Schoenborn
Mrs. Maud Hill Schroll
James H. Schwabacher, Jr.
Walter H. and Phyllis J. Shorenstein
Mrs. Ferdinand Smith
William and Larissa Smith
Mr. and Mrs. Emmett G. Solomon
Mrs. Muriel McKeivitt Sonne
The Louise A. and Walter Sullivan Foundation

*Deceased

Dr. and Mrs. Samuel Susselman
Mr. and Mrs. Robert M. Sutton
Mr. and Mrs. Daniel G. Volkmann, Jr.
Mr. and Mrs. Brooks Walker, Jr.
T. B. Walker Foundation, Inc.
The C. A. Webster Foundation, Inc.
Brayton Wilbur Foundation
Alfred S. Wilsey/Pat Montandon
Harold and Doris Zellerbach Fund

DONORS

\$500 — \$999

Thomas C. Andersen
Dr. and Mrs. Robert Baer
Mr. and Mrs. Walter M. Baird
Mr. and Mrs. Richard M. Bastoni
Mr. and Mrs. Alfred X. Baxter
Mr. and Mrs. Joachim Bechtel
Mr. and Mrs. John L. Bradley
Mr. and Mrs. Carleton F. Bryan
Mr. and Mrs. John M. Bryan
Mr. and Mrs. Edgar L. Buttner
J. Peter Cahill
California Arts Society
Mrs. John D. Campbell
Frank A. Campini Foundation
Mr. and Mrs. Selah Chamberlain, Jr.
Mr. and Mrs. Ransom Cook
Mrs. John Crosby, Jr.
Dr. Alexander Cross
Mr. and Mrs. John R. Dodds
Mrs. James Durkin
Mr. and Mrs. George C. Dyer
Mr. and Mrs. Milton H. Esberg, Jr.
The Gamble Foundation
The Richard and Rhoda Goldman Fund
Mr. and Mrs. Douglas W. Grigg
Mr. and Mrs. Richard E. Guggenhime
Mr. and Mrs. Richard C. Ham
Dr. and Mrs. Joseph Harvey Harris
Mr. and Mrs. Alfred Heller
Harold Hirsch Foundation
Dora D. Ide
Mrs. Bruce Kelham
Miss Elsa Korbel
Mr. and Mrs. LeRoy Krusi
Lakeside Foundation
Mr. and Mrs. Roger D. Lapham, Jr.
Mr. and Mrs. Bert W. Levit
Mr. and Mrs. John S. Logan
Dr. and Mrs. Herschel H. Loomis, Jr.
Sharon Loomis Trust Fund
Mrs. Ernest O. McCormick
Thomas E. McEvoy
Mrs. Felix McGinnis
Mrs. Merl McHenry
Mr. and Mrs. Richard B. Madden
Mrs. Robert Malcolm
William D. Maus, Jr.
Mrs. Osmond Molarsky
Mr. and Mrs. Graham B. Moody, Jr.
Mr. and Mrs. Albert Moorman
E. M. Nagel

Mrs. Erich Nielsen
J. S. Perkins
Mrs. Lester S. Peterson
Mrs. Thomas M. Price
Mr. and Mrs. Eugene R. Purpus
Dr. Roger Pyle
Mr. and Mrs. John N. Rosekrans, Jr.
Dr. and Mrs. Alan J. Rosenberg
Mr. and Mrs. George B. Schirmer
Mrs. Raymond H. Schubert
Mrs. Martin Seamster
Mr. and Mrs. Roy L. Shurtleff
Mr. and Mrs. Andrew W. Simpson, III
Mr. and Mrs. John L. Simpson
Mrs. Eleanor F. Sloss
Mrs. Louis Sloss
Mrs. T. A. Soong
Marshall Steel Sr. Foundation
Alan L. and Ruth Stein Foundation
Mr. and Mrs. Louis P. Steller
Mr. and Mrs. Ellis M. Stephens
Frank D. Stout
Mr. and Mrs. Augustus Taylor, Jr.
Mr. and Mrs. Alfred T. Tomlinson
Mr. and Mrs. Gardiner Trowbridge, II
Mrs. Ebe Cella Turner
Mr. and Mrs. Brooks Walker
Mr. and Mrs. Edmond C. Ward
Mr. and Mrs. Clem Whitaker, Jr.
Mrs. Eli H. Wiel
Thomas R. Wilcox
Mr. and Mrs. J. Perry Yates
Dr. and Mrs. John A. Zderic

Why smoke Now?

If you're a smoker who has been thinking about 'tar' and nicotine, here's why you might consider smoking Now.

Now has the lowest 'tar' and nicotine levels available to you in a cigarette, king-size or longer: 2 mg. 'tar,' .2 mg. nicotine. It comes in both filter and menthol.

Now also gives you real smoking satisfaction. The flavor is mild and pleasant.

Now draws free and easy for a cigarette so low in 'tar' and nicotine.

Now has a uniquely designed filter that makes all this possible for the first time.

Compare 'tar' numbers. You'll see that 2 mg. is the lowest of all king-size cigarettes.

When is a good time to switch to Now? There's no better time than right now.



Now. 2mg 'tar' is lowest. (King-size or longer.)

©1976—R.J. REYNOLDS TOBACCO CO.

Warning: The Surgeon General Has Determined That Cigarette Smoking Is Dangerous to Your Health.

FILTER, MENTHOL: 2 mg. "tar", .2 mg. nicotine, av. per cigarette by FTC method.

Don't just
fly over!



Jungle wonderland just 12 miles out of Kuala Lumpur.

Come down to earth

Seeing Malaysia from 20,000 feet through a tiny airplane window? You don't know what you're missing! Malaysia has just the right blend of 'exotic' and 'familiar' attractions. Whether you're the brave new breed.... or a wellworn traveller looking for a quiet place in the sun Malaysia will do right by you.

Come on down! Malaysia is warm and sunny and she comes in a thousand shades of green. At a very down-to-earth price.

Malaysia
...the new stopover

For more information, contact:

Malaysia Tourist Information Centre
36th Floor, Transamerica Pyramid Building,
600, Montgomery Street,
San Francisco,
California 94111.

Tourist Development Corporation of Malaysia
Ground Floor, Ampang-UDA Shopping Complex,
Jalan Ampang, Kuala Lumpur. P.O. Box 328.

TRADER VIC'S



**THIS IS THE
ONLY FROWN
YOU'LL SEE AT
TRADER VIC'S**

20 Cosmo Place, San Francisco
776-2232

At last . . .

A new concept for an elegant organization designed specifically for singles.

There will be receptions before and after the performance for people of discerning tastes like yourself.

If you would like to meet others at your level of culture and education and find the kindred feeling found nowhere else

Contact:

*Singles In Concert
1209 Sutter Street #1642
San Francisco, Calif. 94109*

(415) 928-1357

Still Verismo

continued from p. 29

Santuzza only to teach "the bitch" Lola a lesson for marrying someone else in his absence. And Lola falls into the trap by stealing back his affections. Santuzza then responds predictably: "That evil woman stole him from me . . . Turiddu took away my honor." The jealous circle is completed when she informs Alfio of the adultery.

One does not play upon an Italian husband's jealous instincts lightly—as both Canio ("Jokes like that you'd better not play on me") and Alfio ("If you are lying, I'll tear your heart out!") have occasion to warn. Incidentally, modern instances of jealousy and not-so-rustic chivalry are to be found in much modern Italian cinema—particularly in the currently modish films of Lina Vertmüller.

* * *

"There is release in violence, no matter how futile the motive. An argument is a purge. He can rage at home and rant in public and for once he has in his grasp something he can manage. What should be at most a pointless feud can (and now and then does) become a knife slashing or worse, a murder . . . an involuntary catharsis that man resorts to when poverty, boredom and frustration overload his reason."

As Cornelisen points out many times, things "get done" in Southern Italy largely by feminine ingenuity and domestic diplomacy, not by the blunt, frontal, and often violent masculine attacks of husbands. Southern women let their *chicchierone* ("gasbag") spouses spout off in the *piazza*, while

continued on p. 76

Made for Each Other

The WEDGE
Model H596W



The "Odd Couple" was a great play, but when it comes to stereo systems you want your components to be compatible. That's why the Zenith amplifier and exclusive Tuned-Port Allegro speakers are engineered to work together to give rich, natural sound. And you can choose models with a wide range of features like cassette or 8-track play and record.

For the best stereo at the best price, see the Allegro modular system by Zenith . . . stereo systems matched for Matchless Performance — at your Zenith Dealer.



*The quality goes in
before the name goes on®*



REDWOOD ROOM

On your next night out...
Dine in elegance,
with impeccable service.
Specialties include
Roast Prime Ribs of Beef
and freshly-caught fish.
Complemented by the
finest wines, superb
coffee brewed fresh every
thirty minutes and incred-
ible French pastries.
Open daily.
Dinner: 5-11:00 p.m.
Lunch: 11:30 a.m.-5 p.m.
Breakfast: 6:30-11:30 a.m.

Also enjoy cocktails
in the luxurious
Redwood Room Lounge.

Meetings, Dinners, Parties and Receptions

Private rooms accommo-
dating from 20 to 350 are
available for your social
and business functions.

The Clift

Geary and Taylor
San Francisco
775-4700



A Four Seasons/Inn on the Park Hotel

Profiles

TATIANA TROYANOS



Singing *Santuzza* in the first five performances of *Cavalleria Rusticana* (October 27, 30, November 3, 10, and 13), Tatiana Troyanos made her sensational San Francisco Opera debut last season as *Poppea* in *L'Incoronazione di Poppea* and *Adalgisa* in *Norma*. Born and raised in New York, the mezzo soprano spent eleven years with Hamburg State Opera, performing an extensive variety of roles, such as *Eboli* in *Don Carlo*, *Santuzza*, *Carmen*, *Dorabella*, *Octavian* and *Poppea*. She additionally made frequent guest appearances with other European opera companies, and her interpretation of the *Composer in Ariadne auf Naxos* at the 1966 Aix-en-Provence Festival launched her international reputation. In this country a few of her memorable performances include her first *Charlotte* in *Werther*, her debut rôle with Lyric Opera of Chicago, and her singing of the title role of *Händel's Ariodante* for the opening of the Kennedy Center for the Performing Arts, in Washington, D.C. She made a stunning debut with the Opera Company of Boston, as *Romeo* in Bellini's *I Capuletti ed I Montecchi* in 1975, the year she also made her Metropolitan Opera debut as *Octavian* in *Der Rosenkavalier*, followed by the *Composer in Ariadne auf Naxos*. On discs she is represented by Penderick's *The Devils of Loudon*, *Händel's Giulio Cesare*, Beethoven's Ninth Symphony with Maestro Karl Böhm, her recent *Carmen* with Plácido Domingo and Sir Georg Solti, and *Bluebeard's Castle*, conducted by Pierre Boulez. Following her San Francisco Opera performances, Miss Troyanos returns to the Metropolitan Opera for the role of *Amneris* in *Aida*, and the *Countess* in that company's premiere staging of *Berg's Lulu*.

REGINE CRESPIN



French mezzo soprano Regine Crespin joins San Francisco Opera for her sixth season, interpreting *Santuzza* in the final four performances of *Cavalleria Rusticana* (November 16, 21, 24, and 27). Miss Crespin last appeared here in the 1970 *Tosca*, and is well remembered for her interpretations of *Cassandra* and *Dido* in *Les Troyens* in 1966 and 1968, her *Sieglinde* in *Die Walküre* in 1968, and her *Rosenkavalier Marschallin* in 1967. Born in Marseilles, she entered the Paris Conservatory where she studied singing and made her Opera-Comique debut as *Tosca*, followed by her Paris Opera debut as *Elsa* in *Lohengrin*. Over the next several years she became internationally known for her singing of *Sieglinde*, *Marguerite* in *The Damnation of Faust*, and the *Marschallin*. She made her Bayreuth festival debut in 1958 as *Kundry* in *Parsifal*, followed by her La Scala debut a year later in a revival of Pizzetti's *Fedra*. Next came an American operatic debut as *Tosca* in 1962 with Lyric Opera of Chicago, and that same year was the *Marschallin* for Metropolitan Opera. During the 1975-76 season, Miss Crespin sang the first *Carmen* in her career at the Metropolitan and performed in a concert performance of Massenet's *Marie Magdelaine* at Carnegie Hall. In February of 1977 she will perform in the Metropolitan Opera premiere of *Dialogue of the Carmelites*.

NOELLE ROGERS



Young soprano Noelle Rogers interprets Nedda in the first six performances of *I Pagliacci* (October 27, 30, November 5, 10, 13, and 16), her debut with San Francisco Opera. Miss Rogers initially studied French horn at the University of Michigan until she discovered her vocal talents. Upon graduation she entered and won the Detroit Grand Opera contest and was a national finalist in the Metropolitan Opera Auditions. With Opera Society of Washington, she electrified audiences with her portrayal of the title role in *L'Incoronazione di Poppea* in 1973, recreating her interpretation in 1974. Her popular and critical success in the Monteverdi work led to her subsequent engagement as Thaïs in 1976. Miss Rogers' *Poppea* will be performed this season at Houston Grand Opera, where she debuted in Händel's *Rinaldo* in 1975. With added triumphs at Philadelphia Lyric Opera and New York City Opera, the soprano traveled to Europe, where she performed at the Aix-en-Provence Festival, Theatre Municipal in Marseilles, and Royal Opera. As a guest soloist, she has sung with the Philadelphia and Cleveland Orchestras, as well as the symphonies of Boston, Detroit, and St. Louis, among others. Miss Rogers recently made her cinematic debut portraying Lucille du Charmes, "the coloratura from Colorado" in Robert Altman's irreverent look at entertainment and the old West, "Buffalo Bill and the Indians."

RAINA KABAIVANSKA



Last heard at San Francisco Opera as Desdemona in the 1970 staging of *Otello*, Raina Kabaivanska returns to the company as Leonora di Vargas in November performances of *La Forza del Destino* and Nedda in the last three performances of *I Pagliacci*. After piano and vocal studies in Sofia and Italy, the soprano made her professional operatic debut at La Scala in 1960, singing with Joan Sutherland in Bellini's *Beatrice di Tenda*, performing regularly with the Milanese company during the next four years. In 1962 the singer made her American debut as Desdemona with San Francisco Opera, and later repeated the role for her first performances at Covent Garden. At the Metropolitan Opera, she has sung in *I Pagliacci*, *La Bohème*, *Falstaff*, *Don Carlos*, *Manon Lescaut* and *La Forza del Destino*. A sought-after artist by many of the world's foremost opera companies, Miss Kabaivanska has recently interpreted roles in *Simon Boccanegra* with La Scala, *La Forza del Destino* with Paris Opéra, *Il Trovatore* with Hamburg Opera, as well as *Madama Butterfly* for Bologna and *La Wally* for the Teatro Regio in Parma. She has sung on numerous occasions with the opera companies of Sofia and Budapest, and appeared as guest artist with the Teatro Colon in Buenos Aires, Lyric Opera of Chicago and the San Carlo in Naples, among others. New additions to her repertoire include *Thaïs*, Marguerite in Gounod's *Faust* and Margherita in Boito's *Mefistofele*. In April, 1977, the Bulgarian soprano will perform *Tosca* at Covent Garden.



MICHAEL BARCLAY

Internationally acclaimed opera educator will present four exciting and informative Opera Classes in 1977:

VERDI'S OPERAS, THE OPERAS OF RICHARD STRAUSS, THE STUDY AND APPRECIATION OF OPERA, AND AN INTRODUCTION TO OPERA FOR YOUNG PEOPLE!

This year, for the first time ever, classes will be offered in MARIN COUNTY and MID-PENINSULA as well as SAN FRANCISCO and BERKELEY.

Please send me full information on Michael Barclay's opera classes when available:

Name _____
 Address _____
 City _____
 State _____ Zip _____

Mail to:
OPERA EDUCATION WEST
 400 Yale Avenue, Berkeley, Ca. 94708
 or call (415) 526-5244

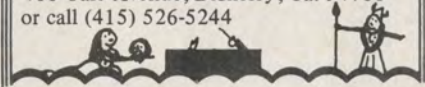

Been to any bad restaurants lately?

We have.

Of the six nights a week we spend in restaurants, at least half prove pretty ghastly dining experiences.

But our subscribers don't have to suffer the same fate. We tell them which places are tops and which scrape bottom. In detail. And with no punches pulled, since we accept no advertising.

A subscription is just \$20 for twelve monthly issues. We'd be pleased to send you a sample with our compliments.

Leave the heartburn to us.

After ten years, we've learned to live with it.

Jack Shelton's Private Guide to Restaurants

100 Bush Street—Dept. I
 San Francisco, CA 94104
 phone (415) 421-7262



La Mère Duquesne

French Country
Dining in Simple
Elegance

Luncheon & Dinner

101 SHANNON ALLEY
off Geary

between Taylor & Jones
776-7600

KENDURINA



Atmosphere, Entertainment, Gourmet Cuisine

Every Evening
from 4:40 - 8:30 is
Cocktail Party Time.

For a relaxing fun-
evening see and hear
The GINNY TIU SISTERS
at the lounge from
8:30 - midnight.

No Cover or Minimum

325 Sacramento St. • San Francisco
(across from One Embarcadero)
433-3770 - Closed Sundays

FAITH ESHAM



Young American mezzo soprano Faith Esham debuts with San Francisco Opera this season as Lola in *Cavalleria Rusticana*. She received her Bachelor of Arts degree in psychology from Columbia Union College and afterwards attended Eastern Kentucky University where she studied clinical psychology. In 1976 Miss Esham received her Bachelor of Music degree at the Juilliard School having studied with Giorgio Tozzi and the late Jennie Tourel. Her Juilliard roles were Popova in William Walton's *The Bear*, Dora-bella in *Così fan tutte*, and Cherubino in *Le Nozze di Figaro*. An Apprentice Artist with Santa Fe Opera in 1973 and 1974, she received excellent notices for her solo debut as Cupid in Cavalli's *L'Egisto* in its American premiere in 1974, and when it was repeated this past summer. In the last two years at Santa Fe, she has also sung Mercedes in *Carmen*, the title role in Ravel's *L'Enfant et les Sortilèges*, and Cherubino in *The Marriage of Figaro*. Following her San Francisco Opera performances, Miss Esham will travel to Fort Worth to perform Mercedes.

DONNA PETERSEN



For her fifteenth season as a member of San Francisco Opera, Donna Petersen sings Grimgerde in *Die Walküre*, Mrs. Sedley in *Peter Grimes*, a child and a solo voice in *Die Frau ohne Schatten*, Mamma Lucia in *Cavalleria Rusticana* and Ada Hawkes in *Angle of Repose*. Last year, the mezzo soprano was Inez in *Il Trovatore*, Mary in *Der Fliegende Holländer*, the Governess in *Pique Dame* and Amelia's servant in *Simon Boccanegra*. Among her past roles with the company are Mother Goose in *The Rake's Progress*, Filip-eyvna in *Eugene Onegin*, Marcellina in *Le Nozze di Figaro* and Giovanna in *Rigoletto*. In addition to interpreting 25 roles with San Francisco Opera, Miss Petersen has toured extensively with Western Opera Theater and appeared with Spring Opera Theater where she was last heard in the 1974 production of *L'Ormino*. A performer with San Diego Opera and Guild Opera of Los Angeles, she made her highly successful Lyric Opera of Chicago debut in 1974, as Mrs. Sedley in *Peter Grimes*, a role she will repeat with that company in 1977. Miss Petersen additionally performs as guest soloist with the San Francisco, Oakland and Honolulu Symphonies and the Los Angeles Philharmonic. She was recently awarded the Knight's Cross of the Royal Order of Denneborg by Her Majesty Queen Margarethe II of Denmark, an honor recognizing Miss Petersen's service to the Danish-American community of Northern California.

PLACIDO DOMINGO



JUAN LLOVERAS



Placido Domingo, one of the world's foremost tenors, returns to San Francisco Opera to sing both Turiddu and Canio in the first six performances of *Cavalleria Rusticana* and *I Pagliacci* (October 27, 30, November 5, 10, 13, and 16). The eminent Spanish artist has appeared previously with the company as Rodolfo in *La Bohème* (1969), Don Jose in *Carmen* (1970), Cavaradossi in *Tosca* (1970 and 1972), Manrico in *Il Trovatore* (1971), Vasco da Gama in *L'Africaine* (1972) and the title role in last season's highly regarded staging of *Andrea Chenier*. Domingo's first public performance was in Mexico in 1961 and since then his rise to fame has been meteoric. He sang in Ginastera's *Don Rodrigo*, which opened New York City Opera's first season at Lincoln Center in 1966, and in 1970 portrayed the title role in Donizetti's *Roberto Devereux*. His busy international schedule during 1976 has thus far included performances of *Cavalleria Rusticana* and *I Pagliacci* at Covent Garden, *Turandot* in Barcelona, *Aida* and *Carmen* at the Metropolitan Opera, *Tosca* in Munich, *Otello* at La Scala and Paris Opéra, the title role in *Le Cid* with the Opera Orchestra of New York, and the title role in *Les Contes d'Hoffmann* at Lyric Opera of Chicago. A prolific recording artist, the tenor recently sang opposite Tatiana Troyanos' *Carmen*, and also recorded Montemezzi's *L'Amore dei Tre Re*. With his good friend and colleague Sherrill Milnes, Domingo has pursued conducting and has made a recording in which he and Milnes conduct for each other. Domingo will grace San Francisco Opera's podium as conductor for a student matinee performance of *The Barber of Seville*.

Juan Lloveras, an artist who is part of the new generation of Spanish tenors, comes to San Francisco Opera for a second season, singing Turiddu in the final three performances of *Cavalleria Rusticana* (November 21, 24, 17). His debut role last season was Manrico in the November stagings of *Il Trovatore*, performed with Renata Scotto. Born in Villanueva y Geltrin near Barcelona, Lloveras' vocal talents were discovered by chance when he was serving in the military. He subsequently studied at the Barcelona Conservatory, and was additionally instructed by Manuel Cots and Enriqueta Garetá. The turning point of the tenor's career occurred in 1965 when Placido Domingo heard Lloveras sing at the Teatro Liceo in Barcelona and recommended the artist as his replacement at the Hebrew National Opera in Tel Aviv. After three years with that company, Lloveras moved to Germany, performing with the opera companies of Krefeld and Essen before joining Hamburg State Opera in 1974. He has since been heard on numerous European opera stages, such as Berlin, Paris, Munich, Cologne, Düsseldorf, Frankfurt and Prague. His repertoire originally consisted of lyrical roles, such as Don Ottavio and Almaviva, and he has since added the roles of Rodolfo in *La Bohème*, Alfredo in *La Traviata*, the title role in *Faust* and Edgardo in *Lucia di Lammermoor*, as well as Cavaradossi in *Tosca*, Pinkerton in *Madama Butterfly* and Enzo in *La Gioconda*.

HARCOURTS GALLERY



Juchitecas, Francisco Zuniga

Now Showing Mexican Artists:

DAVID ALFARO SIQUEIROS

DIEGO RIVERA

FRANCISCO ZUNIGA

RUFINO TAMAYO

JOSE CLEMENTE OROZCO

PEDRO FRIEDEBERG

JOSE LUIS CUEVAS

R. V. TABUENA

HARCOURTS GALLERY

535 Powell Street
San Francisco, CA 94108
(415) 421 3428

PRECIOUS
JEWELS

An Original Design by Paul de Vries



A spectacular
bracelet of
sapphires and
diamonds.

\$5800.

982-5571

Paul de Vries
et Cie

445 Sutter St.

BRUNO PREVEDI



Having made his debut earlier this season as Don Alvaro in *La Forza del Destino*, tenor Bruno Prevedi interprets Canio in the final three performances of *I Pagliacci* (November 21, 24, 27). Born near Mantua, Italy, Prevedi first performed on the operatic stage of the Teatro Nuovo in Milan in *I Pagliacci*, receiving both popular and critical acclaim. He has sung throughout the world at such respected operatic centers as Rome, Paris, Naples, Milan, Budapest, Florence, Barcelona, Venice, Berlin, Vienna, Genoa, Athens, Buenos Aires, New York and London. In 1975 the tenor was in Hamburg State Opera productions of *Aida*, *Cavalleria Rusticana*, *La Forza del Destino* and *Don Carlo*. That same year he appeared in Boito's rarely-staged *Nerone* in Turin, and in *Simon Boccanegra* in Zurich. His performance schedule this year has thus far included *La Bohème* in Johannesburg, *Fedora* in Catania and Caracas, and additional readings of *Simon Boccanegra* in Zurich. His diverse repertoire includes Dimitri in *Boris Godunov*, Jason in *Medée*, Ishmael in *Nabucco*, Foresto in *Attila*, Pollione in *Norma*, and Maurizio in *Adriana Lecouvreur*. A frequent performing artist with Italian National Radio, in 1974 Prevedi participated in special broadcasts of *Fernand Cortez* and *Agnes von Hohenstaufen*, commemorating the bicentennial of composer Gasparo Spontini's birth. During the 1976-77 operatic season, Prevedi is scheduled to perform with Zurich Opera.

WASSILI JANULAKO



Wassili Janulako returns for a second season with San Francisco Opera singing Alfio in *Cavalleria Rusticana*. The baritone made his debut here as Iago in the 1974 Jean Pierre Ponnelle production of *Otello*. Born in Athens, Janulako earned his degree in economics before entering the Greek National Conservatory to study voice. He made his operatic debut in 1959 singing Valentin in *Faust* at the Athens Festival. From 1961 through 1963 the singer performed with Düsseldorf's Deutsche Oper am Rhein and appeared regularly at the Athens Festival. In 1963, he added Nürnberg to the growing list of cities where he has performed, interpreting roles in *Don Carlo*, *Aida*, *Les Contes d'Hoffmann*, *Faust*, *Don Pasquale*, *Il Trovatore* and *La Forza del Destino*. In 1968 at the Graz Festival he performed in the first Austrian staging of the revised edition of Milhaud's *Christopher Columbus*. During the next seven years, he added debuts and regular performances at Cologne, Vienna, Munich, Berlin, as well as Stuttgart in 1973. His repertoire includes roles in *Don Giovanni*, *Tosca*, *I Vespri Siciliani*, *La Traviata*, *La Bohème*, *Fidelio* and *Parsifal*. Immediately prior to coming to San Francisco Opera, Janulako was in the Cologne Opera production of *La Fanciulla del West*.

INGVAR WIXELL



A favorite baritone of San Francisco Opera audiences, Ingvar Wixell joins the company for a seventh season singing Scarpia in *Tosca* and Tonio in the first six performances of *I Pagliacci*. Last season at this house he received excellent notices for his contrasting roles of Count di Luna in *Il Trovatore*, the title role in *Simon Boccanegra* and Sergeant Belcore in *L'Elisir d'Amore*. He additionally performed with Luciano Pavarotti in a special Golden Gate Park concert, conducted by Kurt Herbert Adler. Previous performances here are Valentin in *Faust*, Marcello in *La Bohème*, Figaro in *Il Barbiere di Siviglia*, Sharpless in *Madama Butterfly*, Ping in *Turandot* and Iago in *Otello*. A permanent member of Deutsche Oper Berlin and Royal Opera of Stockholm, the baritone has also sung as a guest artist with Munich State Opera, Hamburg Opera, Covent Garden, La Scala, Vienna State Opera and the Metropolitan Opera. Wixell frequently performs at various European festivals, notably Salzburg and Bayreuth, where his roles have included Count Almaviva in *Le Nozze di Figaro*, Wolfram in *Tannhäuser* and the Herald in *Lohengrin*. Last season, Wixell portrayed Scarpia opposite Leonie Rysanek's *Tosca* when Deutsche Oper Berlin visited the Kennedy Center in Washington, D.C., and interpreted Germont during Beverly Sills' first Metropolitan Opera performance of *La Traviata*. He has recorded Count Almaviva in *Le Nozze di Figaro* and the title role in *Don Giovanni* with conductor Colin Davis, as well as the Verdi comedy *Un giorno di regno*. At the end of his San Francisco Opera duties, Wixell will sing a series of Marcellos in *La Bohème* with the Metropolitan Opera.

PETER GLOSSOP



After an eight year absence, English baritone Peter Glossop joins San Francisco Opera as Tonio in the final three performances of *I Pagliacci* (November 21, 24, 27). The singer was last heard at this house as Don Carlo in the 1968 staging of *Ernani*, and previously performed Rodrigo in *Don Carlo* and Rigoletto in 1966. After World War II had interrupted it, he resumed his musical training, making his professional debut with Sadler's Wells (now English National Opera) in 1952. Within a year the artist was a principal baritone with that company, having special successes as Rigoletto, di Luna in *Il Trovatore* and Scarpia in *Tosca*. In 1961 the singer won first prize at the international operatic competition in Sofia, Bulgaria, and the next year was engaged as a principal baritone with Covent Garden. In 1965 he made his La Scala debut as Rigoletto, a role he has performed to critical praise throughout Italy. An international favorite, Glossop has performed at the Teatro Colon in Buenos Aires, and in Paris, Boston, Palermo, Berlin, Naples, Parma, and Hamburg. He made a sensationally successful debut at the Vienna Staatsoper in 1968 singing no less than five different roles in seven performances during a period of twenty days. His recent activities have included performing the title role in *Wozzeck* with the Metropolitan Opera in 1974, the title role in *Falstaff* at Trieste in 1975, and Iago in Herbert von Karajan's new film of *Otello*, with Jon Vickers and Mirella Freni. In 1976, Glossop has sung Michele in *Il Tabarro* at Covent Garden, as well as Tonio in *I Pagliacci*.

At Caravansary,
the show goes on
before the curtain
goes up.*



Light, delicious pre-theatre
suppers a specialty

Caravansary

restaurant/gourmet gallery
now at 310 Sutter St.
for reservations, 362-4640

Also at 2263 Chestnut St.
in the Marina
for reservations, 921-3466

*Tell your waiter you're going to the Opera,
and we'll get you there on time.

**A METROPOLITAN OPERA
EXTRAVAGANZA!**

FEBRUARY 20 - 27, 1977



MICHAEL BARCLAY presents
A ONE-WEEK TOUR
to America's Grandest Opera House

NINE GREAT OPERAS

Forza Del Destino, Dialogues of the Carmelites, Bohème, Suor Angelica, Walkure, Gianni Schicchi, Le Prophete, Il Tabarro, Figaro

Dozens of Opera's Super-Stars Including:
Scotto, Price, Leinsdorf, Pavarotti, Horne,
Talvela, Rysanek, Domingo, Milnes, Mac
Neil, Crespin, Verrett, Levine . . .

AND

Luxurious accommodations at the Plaza
Hotel; Daily Opera Previews; Gala Opera
Dinner; Back-Stage Tour of Met; Private
Guides to Dining, Shopping and MUCH
MORE!

Please rush me full details about Mr.
Barclay's Metropolitan Opera Tour.

OPERA EDUCATION WEST TOURS
400 Yale Avenue, Berkeley, Ca. 94708
or call (415) 526-5244

Name _____
Address _____
City _____
State _____ Zip _____

THE OBELISK

526 Castro Street
San Francisco
(415) 863-9217

18" Alabaster obelisk - \$47.50
Sphere on base - 10½" \$39.50



Photo by John David Hough



beautiful, bountiful
Buena Vista breakfasts
from 9 am

impeccable, inimitable
irish coffee and other
libations until 2 am

the Buena Vista

foot of hyde overlooking the golden gate
san francisco

BRENT ELLIS

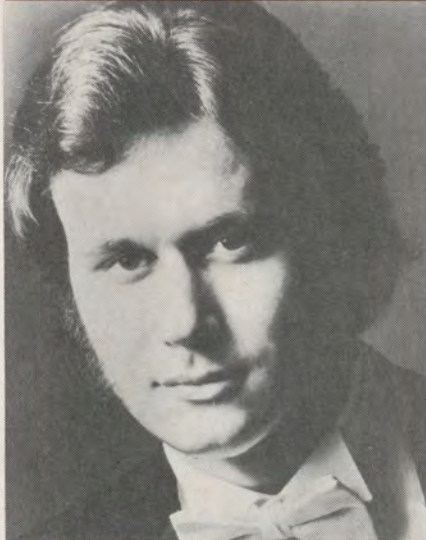

One of this country's gifted young baritones, Brent Ellis joins San Francisco Opera for the first time this season, debuting as Silvio in *I Pagliacci*, and also performing the title role in student matinee performances of *The Barber of Seville*. Ellis sang in the highly regarded 1974 Spring Opera Theater production of Carlisle Floyd's *Of Mice and Men*. His 1976 performance schedule has already included his impressive debut with the Opera Company of Boston in the United States premiere of Roger Sessions' *Montezuma*, under the direction of Sarah Caldwell. This past summer Ellis was heard as Ford in *Falstaff*, Escamillo in *Carmen* and Guglielmo in *Così fan tutte* with Santa Fe Opera, where he was an apprentice artist in 1966 and 1967. He made his operatic debut in Opera Society of Washington's 1966 world premiere of Ginastera's *Bommarzo*. Among his critically acclaimed performances are Ottone for Opera Society of Washington and New York City Opera productions of *L'Incoronazione di Poppea*, Valentine in *Faust* with Houston Grand Opera, Ipparco in Cavalli's *L'Egisto* at Santa Fe, and Constantine in Pasatieri's *The Sea Gull*, with Seattle Opera. Immediately prior to coming to San Francisco, Ellis created the role of Morris Townsend in the Michigan Opera Theater world premiere staging of Pasatieri's *Washington Square*. After his San Francisco Opera performances, the singer interprets his first *Don Giovanni* for Omaha Opera, Ottone for Houston Grand Opera, and next summer makes his Glyndebourne debut as Ford in the Ponnelle staging of *Falstaff*.

JOSEPH FRANK

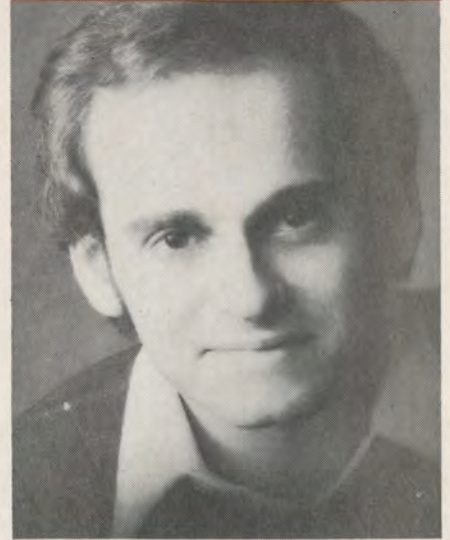

Tenor Joseph Frank adds four members to his San Francisco Opera gallery of operatic characters: Trabuco in *La Forza del Destino*, Spoletta in *Tosca*, Reverend Horace Adams in *Peter Grimes* and Beppe in *I Pagliacci*. Last season's audiences will remember him for his portrayals of Valletto in *L'Incoronazione di Poppea*, the Master of Ceremonies in *Pique Dame*, Incredible in *Andrea Chenier*, the Song Vendor in *Il Tabarro* and Monostatos in *The Magic Flute*. In 1975-76, at the end of his second San Francisco season, Frank sang in *Manon* with Omaha Opera and *La Fanciulla del West* with Houston Grand Opera. After an appearance in Capetown, South Africa, as Almaviva in *Il Barbiere di Siviglia* in 1974, Frank returned to San Francisco where he received critical praise for his interpretation of Pedrillo in the 1975 Spring Opera Theater presentation of *The Abduction from the Seraglio*. He has been a featured soloist with the Central City Opera Company of Colorado and a member of the opera department of the Curtis Institute of Music in Philadelphia. In 1973 the versatile artist made his New York debut with bravura interpretations of the Madwoman in *Curlaw River* and the Temptor-Abbot in *The Prodigal Son*, both part of Benjamin Britten's *Three Church Fables*. In the summer of 1976, Frank was associated with Cincinnati Opera, singing in *Carmen*, *Tosca*, *The Ballad of Baby Doe* and Jerome Kern's musical *Showboat*.

JAMES HOBACK



Young tenor James Hoback makes his San Francisco Opera debut as the Apparition of a Youth in *Die Frau ohne Schatten*, and subsequently performs here as the First Farmer in *I Pagliacci*, the Second Miner in *Angle of Repose*, as well as an Officer in the student matinee performances of *The Barber of Seville*. Immediately prior to the start of the season, Hoback was a finalist in the San Francisco Opera Auditions Grand Finals, winning the Il Cenacolo Award. A participant in the 1976 Merola Opera Program, he sang Nathanaël and Ptitichinaccio in the Sigmund Stern Grove performances of *The Tales of Hoffmann*, and interpreted Enrico in the Merola Fund benefit performance of Donizetti's *L'Ajo nell'Imbarazzo* at the Paul Masson Mountain Winery. The tenor made his Spring Opera Theater debut in 1976 as Federico in *L'Amico Fritz*. He portrayed the title role in *Albert Herring* this spring for the inaugural season of St. Louis Opera Theater. A Bachelor of Music graduate of the North Carolina School of the Arts, Hoback performed for three years with the Curtis Institute of Music Opera Theater.

JOHN DAVIES

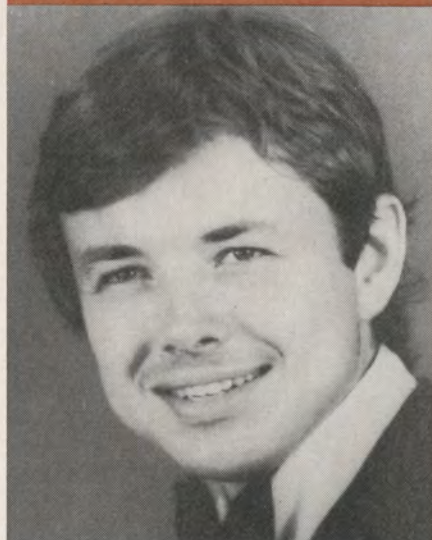

During his second season with San Francisco Opera, John Davies sings a Surgeon in *La Forza del Destino*, the Jailer in *Tosca*, a Stagehand in *The Makropulos Case*, the Second Farmer in *I Pagliacci* and the First Miner in *Angle of Repose*. In his 1975 debut season, the bass baritone displayed his special singing and acting talents in productions of *Il Trovatore*, *L'Incoronazione di Poppea*, *Werther* and *Andrea Chenier*. A two-year veteran of Western Opera Theater, he performed in the 1976 production of *The Barber of Seville* as Bartolo, *The Marriage of Figaro* alternating as Figaro and Antonio, and *The Portuguese Inn* as Roselbo. A native of Boston, Davies toured with Opera New England in 1974, singing the Bonze in *Madama Butterfly* and the Crapshooter in Lukas Foss' *The Jumping Frog of Calaveras County*. In October, 1974, he performed the title role in the coronation scene of *Boris Godunov* with the Detroit Symphony Orchestra at the Worcester Music Festival. A graduate of the Boston University of Fine and Applied Arts, Davies sang in the New Opera Company of Boston production of *The Marriage of Figaro* and the Opera Company of Boston's staging of *War and Peace*. This past summer, Davies made his second appearance as a soloist during the San Francisco Symphony Pops Concerts, conducted by Arthur Fiedler.



The new Parisien meeting place for good drinks and conversation. Crepes, quiches, casseroles, mousse, escargots . . . created by a French chef. Lunch weekdays, dinner nightly and Sunday brunch. Reasonable prices.

BAR et Restaurant
PARISIEN Van Ness at Green 776-4666

**ALWAYS
TOP
PERFORMANCE**



**ADMINISTRATIVE
OFFICE:**

**2601 Mission Street
San Francisco 94110
415/648-8800**



**Royal Gate
Vodkabh.**

Get 'ahh'quainted.

80 Proof. Distilled from Grain. Royal Gate Co., San Francisco.



**Consistent
Kantonese
Culinary
Charisma**

冠園 Kan's

708 Grant Ave San Francisco
982-2388

KENNETH SCHERMERHORN

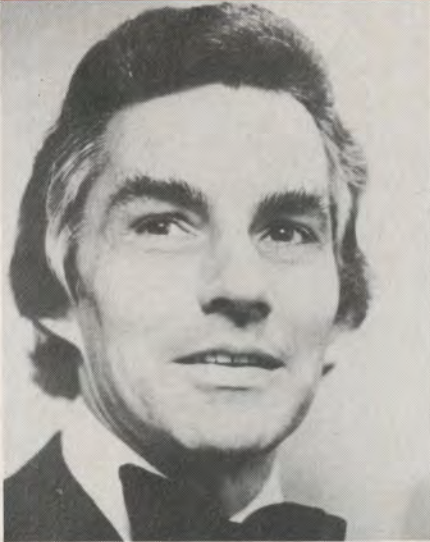

Maestro Kenneth Schermerhorn is reunited with director-designer Jean Pierre-Ponnelle at San Francisco Opera this season, conducting *Cavalleria Rusticana* and *I Pagliacci*. For his debut with the company, Schermerhorn led performances of last year's unorthodox Ponnelle staging of *Der Fliegende Holländer*. Conductor and music director of the Milwaukee Symphony Orchestra, Schermerhorn received his musical training at the New England Conservatory of Music, from which he graduated with the highest honors. He began his career as an instrumentalist with the Kansas City and Boston symphonies and first became an active conductor in Germany as director of the United States Seventh Army Symphony Orchestra. When he returned to the United States, he joined the faculty of the New England Conservatory, where he received a scholarship to study at La Scala in Milan. Prior to assuming his current position with the Milwaukee Symphony in 1968, he had worked as assistant conductor of the New York Philharmonic under Leonard Bernstein, and later was on the podium, in May, 1974, with the San Francisco Symphony, leading performances of Mahler's Sixth Symphony. Schermerhorn took the Milwaukee Symphony to Chicago in 1975, for an all-Beethoven concert, and also appeared with his wife, soprano Carol Neblett, in the Mostly Mozart Festival in New York. This past spring, he and the Milwaukee Symphony were at the War Memorial Opera House, and in February, 1977, he and Miss Neblett will perform *Der Fliegende Holländer* with Baltimore Opera, and *Don Giovanni*, in March for Milwaukee's Florentine Opera.

JEAN PIERRE PONNELLE

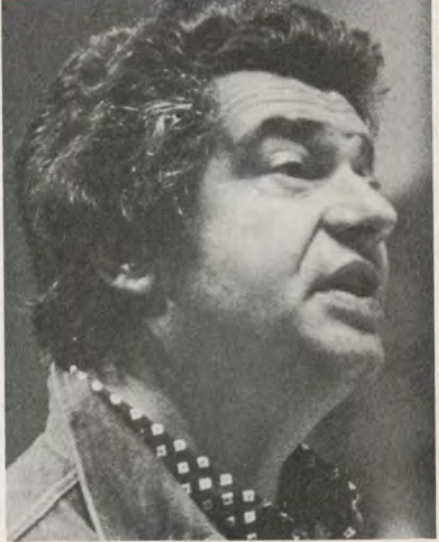

Jean Pierre Ponnelle, perhaps the most sought-after designer-director in opera today, is responsible for the conception of this season's revival of *Tosca* and new productions of *Cavalleria Rusticana* and *I Pagliacci* at San Francisco Opera. Ponnelle made his American directorial debut at this house in 1969 with the highly regarded *La Cenerentola*. His additional productions here were *Tosca* in 1972, *Così fan tutte* and *Rigoletto* in 1973, *Otello* in 1974 and last season's much discussed *Der Fliegende Holländer* and *Gianni Schicchi*. Ponnelle attended the Sorbonne in Paris, studying under Fernand Léger. At 18 he designed costumes and scenery for Hans Werner Henze's opera *Boulevard Solitude*. He has since produced opera and comedy in virtually all the major theaters of the world, including the opera houses of Vienna, Milan, Paris, London, Munich, New York and Chicago, as well as the festivals at Salzburg, Edinburgh and Glyndebourne. In recent years Ponnelle has received international attention for his films of *Il Barbiere di Siviglia*, *Madama Butterfly*, *Carmina Burana* and the recent *Le Nozze di Figaro*. He has worked with the world's foremost conductors including Karl Böhm, John Pritchard, Herbert von Karajan, Claudio Abbado, James Levine and Seiji Ozawa. Ponnelle staged Mozart's *La Clemenza di Tito* and *Le Nozze di Figaro* this summer at the Salzburg Festival, as well as the new Glyndebourne production of Verdi's *Falstaff*. He will stage the *Ring* cycle in Stuttgart during the 1977-78 season and produce *Don Carlos* for the Metropolitan Opera that season as well. His realization of *La Cenerentola* will be seen at Lyric Opera of Chicago this fall.

THOMAS MUNN

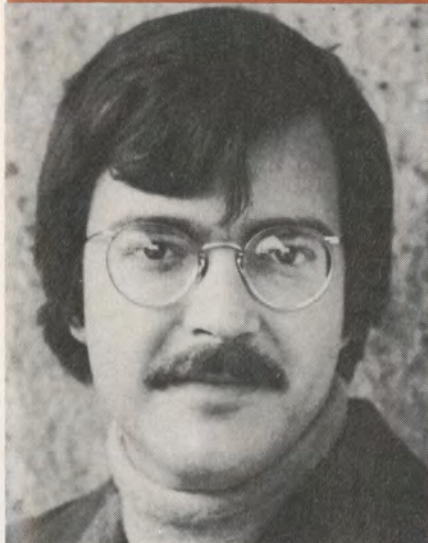

Thomas Munn debuts with this company as lighting designer and director for the International fall season at San Francisco Opera, which includes new productions of *Thais*, *La Forza del Destino*, *Die Frau ohne Schatten*, *Cavalleria Rusticana*, *I Pagliacci* and the world premiere of *Angle of Repose*. A versatile designer whose productions have been seen on Broadway, off-Broadway and in films and television, Munn recently created lighting and scenery for the Netherlands Opera production of *Macbeth*, in conjunction with co-designer Robert Israel. Prior to that Munn designed lighting for the Dutch musical *The Angel of Amsterdam*, written and produced to celebrate the 700th anniversary of that city. He was responsible for the lighting designs for the Lake George Opera Festival productions of *The Crucible*, *Tosca*, *Rigoletto*, *Die Fledermaus* and *La Traviata*, and designed the sets and lighting for the Minnesota Opera Company's *The Magic Flute*. In addition to his work in opera, Munn has designed over 20 industrial shows, and for the past six years has served as principal designer for the Mary Anthony Dance Theater of New York. Between design assignments he has served on the faculty of Columbia University, and has worked as a scenic artist on numerous films, commercials and television productions.

Performing Arts Tours

Performing Arts Magazine is in the process of organizing some unique tours to all corners of the globe. Small groups accompanied by renowned personalities. Relaxed itineraries staying at deluxe hotels and offering the best cuisine.

To assist us in our planning, please answer the following questions. You'll be placed on our mailing list

PERFORMING ARTS TOURS

651 Brannan Street
San Francisco, CA 94107

I would be interested in a tour for:

- Opera
- Symphony
- Theatre
- Ballet
- Gourmet Dining & Wines
- Music Festivals
- Special Interest

I would be interested in a tour to:

- Europe
- Orient
- South America
- Canada
- South Pacific
- Other

I would prefer an all-inclusive tour in the following price range:

- \$1000 or under
- \$1000 to \$1500
- \$1500 to \$2000
- Over \$2000

Name _____

Address _____

City _____

State _____

Zip _____

CAL HIGHLIGHTS

OCTOBER HIGHLIGHTS IN ZELLERBACH AUDITORIUM

Chamber Music Society of Lincoln Center

(Barry Tuckwell, Leonard Arner, Jaime Laredo, Walter Trampler, Leslie Parnar, Richard Goode)
October 24

Paul Sanasardo Dance Company

October 26, 27

The World of Lenny Bruce

with Frank Speiser
October 29, 30

Dimitri

Swiss mime-clown-musician
November 3

The Fires of London

Peter Maxwell Davies, conductor
November 12

Tickets: CAL Ticket Office
101 Zellerbach
U.C. Berkeley (642-2561)
BASS, major agencies

Committee for Arts and Lectures,
University of California, Berkeley

Kyriakos OF HYDRA & Kalliópe

CHRISTMAS COLLECTIBLES

"Road to Rembetika"
by Gail Holst

*Music of a Greek sub-culture
Songs of Love, Sorrow & Hashish



BRONZE HORSE

of the archaic age style

Height 10½" x 7½"

Weight 2½ lbs. 25.00

Available exclusively through
Kyriakos of Hydra & Kalliópe.

SPECIAL GIFTS FOR SPECIAL FRIENDS

Order by Phone 776-0174, 776-4646, 391-1948.

1424 Grant Ave. (upper) and
900 Northpoint, Ghirardelli Square
San Francisco, Ca.
Parking Validation



Rare
Antique Jewelry



Precious and Semi-Precious Stones
Antique and Modern Jewelry
Objects of Art

See our unique Faberge Collection
Ask about our art-restoring services

580 Sutter Street
392-2238

Dine elegantly before the theatre with unique Pacific-Asian cuisine in an atmosphere of unusual simplicity. Featuring Indonesian satays, exotic curries, Malaysian & South Sea specialties.

Lunch 11:30 - 2:30
Dinner 5:30 - 11:30
Reservations: 433-3770
Closed Sundays

KENDURINA



Atmosphere, Entertainment, Gourmet Cuisine

325 Sacramento St. • San Francisco
(across from One Embarcadero)
433-3770 - Closed Sundays

On the Staff

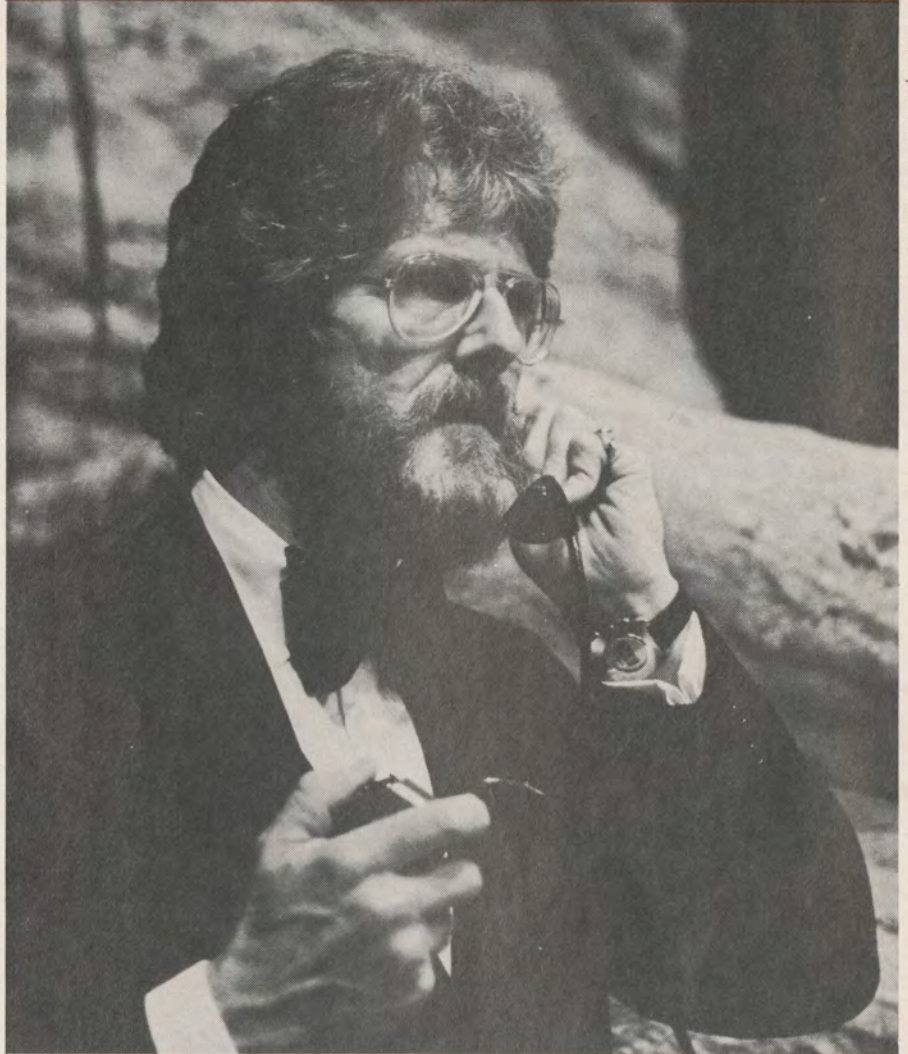

Ralph Clifford

The job of stage manager with San Francisco Opera is sometimes like supervising arriving and departing flights from a busy international airport. In one moment pieces of scenery fly into the loft, other scenic elements quickly move into the wings, while principals, choristers and supernumeraries make frantic dashes off-stage for costume changes or to relocate for new entrances.

Overseeing many evenings of such apparent chaos is Ralph Clifford, senior stage manager for the company, and five year veteran with San Francisco Opera. Ralph first worked with the

company in 1965, was absent for seven years, then returned in 1973.

"Basically, assistant directing and stage managing is all one job," Ralph says taking a quick sip of coffee, the essential beverage for anyone working in theatrical production. "The assistant director is primarily responsible to the director and must know the entire production as it is seen from the front of the house. The 'A.D.' must be able to direct and recreate the production, for revivals or if there must be a cast substitution. The stage manager is responsible to the stage and must know



Dine
tonight
where
San Franciscans
have been eating
since 1898...

The finest seafood
plus a fascinating
harbor view.
Lunch. Cocktails.
Weekend Brunch.

THE WATERFRONT

Pier 7 at Broadway
391-2696 Valet Parking



A Wonderful Way
To Begin Your Evening
At the Theater, the Opera
the Symphony, the Ballet

Grison's STEAK HOUSE

Charcoal-Broiled Steaks . . .
Lobster . . . Rainbow Trout . . .
Prime Rib . . . and other
Specialties Enjoyed by
San Franciscans For More
than 40 Years.

Van Ness at Pacific
San Francisco
(415) 673-1888

Banquet Facilities
Validated Parking

the myriad details of the production to technically achieve a performance." The stage manager "calls" the production from a desk, located on stage right, warning singers of entrances, grips of scene shifts, and keeping the backstage action from becoming noticeable to the audience.

Ralph came to his job with a degree in theater history and acting, acquired from the University of California at Berkeley and Mills College in Oakland. He has worked with numerous touring companies of musicals and legitimate shows, as well as the Jose Limon Dance Company. His first professional theater job was with the local Straw Hat Theater. "It was a tremendous experience, learning to expect the unexpected."

Ralph's schedule, like that of all the stage managers and assistant directors at San Francisco Opera, is often somewhat hectic, involving running from a rehearsal at the Golden Gate Theater, to an on-stage technical rehearsal at the War Memorial, followed by a performance in the evening. In the 1973 season, Ralph was stage manager for nine of eleven productions, which included new stagings of *Rigoletto*, *La Favorita*, and *Peter Grimes*, as well as *Die Fledermaus*, *La Bohème*, *Don Carlo*, *La Traviata*, *Boris Godunov* and *Tannhäuser*, none of which, in terms of bodies on stage or scenic units, are considered "small" shows.

Sometimes Ralph claims he has an "unfair advantage" when calling an opera as stage manager. He often works in San Francisco Opera's busy scene shop, and literally knows a new production from the ground up. "I worked on *Die Frau ohne Schatten* sets this summer, and it was an enormous help when we loaded the show on stage, and were faced with the actual placement of all the set units, and the complexities of the set changes. Here

continued on p. 77

DINE LIKE A SULTAN IN
PALATIAL SPLENDOR

Pasha



OUTSTANDING MIDDLE
EASTERN CUISINE
AND DANCERS

OFF VAN NESS AT
1516 BROADWAY
SAN FRANCISCO,
CALIFORNIA 94109
(415) 885-4477

Put The World's
Best Selling Portable
Dictating Machine
In Your Pocket

- weighs less than 13 oz.
- records up to 30 minutes of notes and ideas



Norelco®
"idea machine"™



CALL:
San Francisco 981-7711
East Bay 655-5050
Peninsula 732-5353
Sacramento 929-6046

U.S. AUDIO & COPY
1315 63rd. Street Emeryville CA 94608

The Status Chimble

9:30-5:30 WEEKDAYS
10-4 SATURDAY

THREADS:

Nantucket, Paternayan, Medici,
Ver au Soie, Linen, Velvet, Gold,
Silver, La Paleta, Oiska, DMC
Floss, Perle & Matte



"A Needle Art & Design Center"

311 Primrose Road Burlingame California 94010 415-344-1737

Award-Winning

designs in
rings & other
fine jewelry.

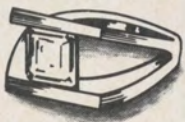

sidney mobell

Designer and Creator of Fine Jewelry

Two fine stores in San Francisco:
141 Post • San Francisco • (415) 986-4747
Fairmont Hotel, atop Nob Hill

CERTIFIED GEMOLOGISTS
ACCREDITED GEM LABORATORY
MEMBER AMERICAN GEM SOCIETY

For your Grand Finale...

The Nob Hill
Restaurant
is now open
until midnight.

Enjoy Bob Moonan
at the piano in the
Lower Bar.

THE
Mark Hopkins
AN INTER-CONTINENTAL HOTEL

San Francisco
392-3434

Still Verismo
continued from p. 63

LANIO
HR. DOMINGO
HR. PREVIEDI

solera

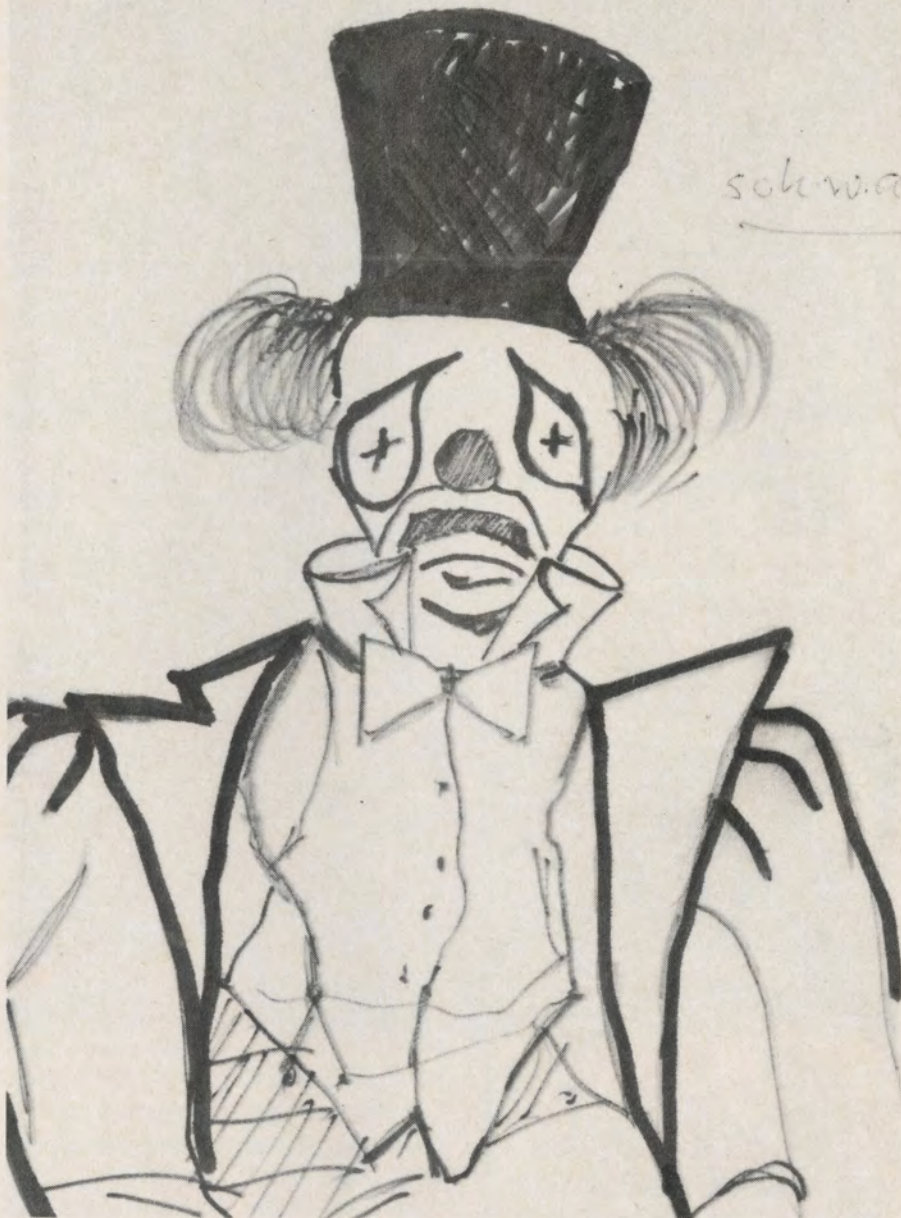

they shoulder nearly all domestic responsibilities. The men of the village—stymied by unemployment but nevertheless possessed of considerable personal pride—release their energies and ease their ennui by taking "heroic" stands on the one ubiquitous issue of marital fidelity or infidelity, real and imagined. This is the centerpiece of the Italian masculine mystique.

Such men are bound to get into trouble, and Turiddu is no exception: an ex-*bersagliere* (the equivalent of our Green Berets) who is now unemployed, not very bright, pettish, and quite handsome. In the typical Italian village, if he had not actually committed adultery, rumor would invent it for him.

continued on p. 78

Canlis' Restaurant in the Fairmont

As San Francisco's cable cars clang softly outside, you'll be pampered in an elegant cosmopolitan atmosphere.

We're very good at getting you to the theatre on time.

And for after-theatre, we purvey our superb cuisine until midnight. Piano bar and sumptuous private dining rooms.

Cocktails: 5 p.m. until 2 a.m.

Dinners: 6 p.m. to midnight.

For reservations call 392-0113.

Closed Sundays.

THE CAPRICE

Now
try the finest
BY-THE-BAY
IN
TIBURON

Now
Open 7 Days a Week
365 Days a Year
for
Lunch and Dinner

THE CAPRICE

2000 Paradise Drive
Tiburon, Calif.
Reservations
(415) 435-3400

On the Staff

continued from p. 75

at San Francisco Opera, no stage manager is any better than the crew, and the backstage support here is absolutely first class. You just don't have to worry; you can concentrate on doing the show, and that makes all the difference in the world."

In addition to his work with the International fall season, Ralph is also associated with Spring Opera Theater. During that company's season, the responsibilities of the assistant director and stage manager are handled by one person, who works closely with the director and then calls the show during its performance run. When asked which productions he's enjoyed working on, Ralph names Bach's *St. Matthew Passion*, *Death in Venice*, *Esclarmonde*, *Peter Grimes* and *Der Fliegende Holländer*.

Two of those five productions involved working with stage director Gerald Freedman, who Ralph is assisting this season with the world premiere production of *Angle of Repose* for San Francisco Opera. "I've been working on the opera for over a year," Ralph reports, "and I'm very excited about it. I'm a native San Franciscan and have a special interest in the history of California." Ralph's interest in local history includes restoring the 1895 Victorian home he and his wife own in the Noe Valley-Diamond Heights area of the city.

Despite his extensive background in theater as well as film, Ralph credits a part-time job as being the biggest influence on his career. "I worked as an usher for six years here at the Opera House and saw every opera performance during that time. I even graduated from high school on the stage of the Opera House." Ralph's experience from those six years makes him the youngest old-timer on the San Francisco Opera staff.

—Paul Chaplin

You Are Cordially Invited



The White Elephant Restaurant

*in the tradition of the
Famous Old London Safari Club*

*featuring
Gourmet fare from the
Continent and beyond
dinners daily 'til 10:30 p.m.*

*luncheon weekdays
pub daily 'til 1:30 a.m.*

*480 Sutter near Powell,
San Francisco*

for reservations 398-1331

80 Proof. Distilled from Grain. Royal Gate Co., San Francisco.

It's "ahh"thentic.

Royal Gate
Vodkahh.



BUENOS AIRES / DUBLIN / EDINBURGH / FLORENCE / HONG KONG / HOUSTON / LONDON / LOS ANGELES /
 AMSTERDAM / BOSTON / BRUSSELS /
 MUNICH / NEW YORK / PARIS / RIO DE JANEIRO / STOCKHOLM / TEHRAN / TORONTO / ZURICH
 MONTE CARLO / MILAN / MELBOURNE / MADRID

Sotheby Parke Bernet

Founded 1744
The largest firm of art auctioneers
& appraisers in the world

... NOW HAS A
REPRESENTATIVE OFFICE
IN SAN FRANCISCO. FOR ALL
INQUIRIES CALL 415/771-0550



Fine and rare early Ming
blue and white dish. Hsüan Te
Period and Mark. Diameter 7 7/8 inches
Sold at Sotheby Parke Bernet
Los Angeles on March 11, 1976
for \$100,000.

Still Verismo

continued from p. 76

Kashian

PERSIAN RUGS

Half a century of experience

• Importer •
Dealer • Appraiser

We will buy your old Oriental rugs

Expert restoration
and hand washing

1610 El Camino Real, Menlo Park
CA 94025 (415) 327-0735



Elegant Dining
San Francisco 397-5969

**San Francisco's
Loftiest Sky-top Restaurant**

Carnelian Room

Dinner nightly
Sunday Brunch

Fifty-two stories above the City.
Haute cuisine and superb views
in a magnificent setting.
Free parking for dinner guests.

**Bank of America Center
555 California Street
Reservations 433-7500**

To us, for whom adultery is usually a matter to be settled by separation, divorce, or even the agreement to be reciprocally adulterous, the solutions in *Cavalleria* and *Pagliacci* are extreme. But they would not raise eyebrows so very much today in Southern Italy. Still common there is the incendiary combination of idleness and frustration which so easily issues in the kind of violence we see in *Cav* and *Pag*.

* * *

[*Cornelisen describes a long-running feud—often taking place within ear-shot of the whole neighborhood — between two women*] “While *Ninetta’s* physical battle with her sister-in-law was unusual, all scenes were played at the level of high drama and with instinctive precision. She knew her audiences well . . . It was not just another squalid fight. The rawness of their emotions, their brutality and the tension it generated may be the classic elements of tragedy, but nowhere else could it have been played at such an extreme pitch, nowhere else would the bystanders have been so lacerated by words which did not concern them. Like *Medea*, it was a totally Mediterranean tragedy . . . Unexpectedly, at the end of one tirade *Ninetta* stopped, coughed and said in a loud but normal voice, ‘*Signore, Signori, andate a letto. Lo spettacolo e finito!*’ ‘Ladies and gentlemen, go to bed. The show is over!’”

Italian opera would probably not seem so exaggerated in its extraordinary extraversion, fierce energy, and concen-

NG

NATHAN GALLERY

2124 union st. ☐ 567-2574
san francisco

VINCENT TAYLOR

Stained glass studio

Offering the highest level of design and execution. Each commission is carefully created for the most compatible integration of stained glass into building structure

(707) 996-8300
P.O. Box 608
Sonoma, California 95476



Holiday Magazine Award Since 1965

After Opera/Theater Suppers



Dinner Served from 5:30 p.m.
Open Till 1:00 a.m.

Hans Brandt Maitre d'Hotel

Alphonse Acheritogaray Chef de Cuisine



Valet Parking

419 O'Farrell Street, San Francisco
776-3600



trated passion if we were more familiar with the high theatrical pitch upon which daily life is lived in the likes of *Pagliacci's* Calabrian village or *Cavalleria's* Sicilian village. This goes beyond the well-known Italian penchant for furious gesticulation to a well-honed sense of timing and suspense, grandstanding manipulation and appeals, and sheer diatribal virtuosity (usually for purposes of malediction, harrassment or vengeance).

All of this is predicated upon the will- ingness, even the desire, to "let it all hang out" before the whole world, or at least the whole village. As Cornelisen often sensed, great outbursts of emotion often implicitly required an audience for their full effect, and the same can be said of Cav and Pag. In most productions, for instance, Santuzza and Turiddu sing their tortured duet alone in the town square. This, contrary to what one might think, is not necessary or even realistic, as the text of Verga's play suggests:

Santuzza: I want to talk to you.

Turiddu: Here? In the middle of the street?

Santuzza: It doesn't matter to me.

Turiddu: Think of all the people that can see!

Santuzza: It doesn't matter to me.

Of course it doesn't matter—everyone in the village knows what has been happening. Besides, Santuzza's agony and despair have pushed her beyond self-respect and—like Cornelisen's NINETTA—into the "public arena" in or-

continued on p. 80



JIMMY

DIAMOND'S IN A NEW SETTING!

TUES. THROUGH SAT. NIGHTS

Direct from Nob Hill—now hear the great Sounds of Jimmy Diamond, in Sumptuous Surroundings—but at a price you can really afford!

DANCING, DRINKING
AND ALL THAT JAZZ

with

No Cover

No Minimum

AT THE BEAUTIFUL



DRINKING ESTABLISHMENT

1500 VAN NESS AT PINE 441-4000

★ FREE COVERED PARKING ★

PRE THEATRE SUPPERS

will be given special attention.

*Finest French Cuisine
at reasonable prices*

Excellent free parking in flood-
lighted area within a few yards of
our door.

Cocktails from 4 p.m. Dinner from
6 Tuesday thru Saturday. From 5
on Sunday.

Reservations recommended.
Phone: 931-5644

Place Pigalle



3721 Buchanan (In the Marina)
Between Bay and Marina Blvd.

SUEHIRO 
RESTAURANT



THE FLAVOR OF JAPAN
Luncheon • Dinner • Cocktails
Japan Center • 1737 Post Street
San Francisco • 922-6400
Closed Tuesdays

Still Verismo

continued from p. 79



Chez Marguerite

French Dinner House
2330 Taylor • 775-9785

American Express BankAmericard Master Charge
Recommended by Holiday Magazine

FOR A SHOW AFTER THE SHOW



Live music • Talented singers
7 nights • No cover • 9 to 2
Cocktails • Snacks
Luncheon from 11:30
Your Hosts:
Harry Grilley Diane Berman

MUSTARD BUILDING
2nd Floor
GHIRARDELLI SQUARE

The
Persian



Delight in a mid-eastern bazaar
Jewelry, antiques, rugs and
handcrafts
(415) 982-5352

347 Grant Ave., San Francisco, Ca. 94108

der to play out her tragedy. That all of *Cavalleria's* scenes of emotional display take place in the *piazza* is in its essence true to Italian life, not a mere expedience of operatic staging. The brief scene, too, where Alfio and Turiddu agree to mortal battle is "played" with splendidly theatrical understatement before the audience of villagers who have doubtless seen the same plot, heard the same script before.

The special irony of the play-within-an-opera of *Pagliacci* is that marital explosions are seldom private — the houses of poor villages being shabby and close-packed and the voices of angry spouses very loud. Privacy is not a prerequisite for towering emotional displays, and so it is easy for Canio and Nedda to slip into their own voices as the comic script crumbles under the weight of genuine tragedy.

* * *

A FOOTNOTE ON *CAVALLERIA*: Giovanni Verga was a close friend of Verdi's greatest librettist Arrigo Boito and Puccini's *Tosca*, *Bohème*, and *Butterfly* collaborator Giuseppe Giacosa (to whom the "Cavalleria" play was dedicated). This perhaps explains why Verga was sensitive to the operatic possibilities of his work. In fact, Verga wrote a letter to a now-forgotten composer, Giuseppe Perrotta, who had asked for permission to set *Cavalleria* to music. In this letter Verga sketched his thoughts:

A piece for small orchestra to introduce the play, a sort of short over-



Charms from around the world and for all special occasions.

The West's largest selection of 14K gold and sterling charms, bracelets, neck chains and fine jewelry.

126 Post Street, Second Floor
San Francisco 94108
986-4960 Now in our 25th year

the House of Charms

The next best thing to flying:
dinner at
THE GRAF ZEPPELIN



Topflight food & service nightly in an intimate setting dedicated to pioneer aviation. First-class cocktails. Deli Lunch weekdays.

100 Vallejo at Front,
San Francisco 398-2770
Free parking for dinner guests across the street.

FOR GRACIOUS DINING
IN TASTEFUL SURROUNDINGS



"The Italian Ristorante"

GENEROUS DRINKS in the UNIQUE

BLACK BART SALOON

COFFEE HOUSE
6:30 a.m. 'til 10:45 p.m.

— Free Parking —

5 Minutes Walk to Opera House

PSA Hotel
San Francisco

MARKET AT CIVIC CENTER
1231 Market Street

FOR RESERVATIONS
(415) 626-8000

THOROUGHBRED RACING

NOW thru December

Tuesdays thru Saturdays



Bay
Meadows
(415) 345-1661 San Mateo

ture and musical recapitulation of its contents, to be played before the curtain rises. It should be simple, clear and effective, well attuned to the subject without being too intricate or difficult, and should breathe the true spirit of Sicily and of rural life . . . The sound of a love song in the night, the longing of Turiddu singing under Lola's window, and the lament of Santuzza who waits in vain for him. Life in the village coming awake, the church bells which summon to the mass. A note of jealousy, and of that love which returns and persists and forms the basis of it all. Finally the frantic outburst of jealous fury, the scream for help, and the outcry of the mother and the beloved.

Perrotta never completed the project, but Mascagni did. Mascagni never saw Verga's letter; in fact, he composed *Cavalleria* even before asking Verga's permission to use the story. But by a kind of artistic ESP Mascagni wrote an opera that fits Verga's general outline remarkably closely.

A FOOTNOTE ON PAGLIACCI: In one respect *Cavalleria* and *Pagliacci* are quite different. The former has little "literary" artifice and unwinds simply. The hand of the author Verga, according to *verismo* principle, is invisible. But from the very first moments of *Pagliacci*, when one of the actors appears to explain the author's purposes (Leoncavallo wrote his own excellent libretto), we are made aware of an

continued on p. 82



GILBERT GALLERIES

FINE PAINTINGS
GRAPHIC ART • SCULPTURE

590 SUTTER STREET
SAN FRANCISCO, CA 94108
392-4119

Continuous Service 11:30 a.m. till Midnite

LEHR'S GREENHOUSE SAN FRANCISCO

Dine in a Garden
in full bloom

NEXT DOOR TO HOTEL CANTERBURY
740 SUTTER NEAR TAYLOR
(415) 474-6478

There's an extra dimension
to home nursing.
It's important.
We provide it.

Skill and experience are basic requirements. So is intrinsic understanding of a patient's needs—and yours. It's often missing.

But not with our RN-supervised nurses. They've got it—or we won't send them to your home. 24-hour service.

MEDICAL
PERSONNEL POOL
Serving the greater Bay Area
(415) 433-5670

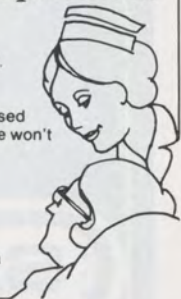

Bardelli's

NO FINER FOOD
ANYWHERE

Monday thru Friday
Lunch and Dinner

Saturday—Dinner Only

Closed Sundays & Holidays
ADJACENT TO THEATRES

243 O'Farrell St.
982-0243

Kenneallys

The oldest existing ski shop in San Francisco introduces the very newest in 1977 ski fashions.

One block from the Montgomery St. BART Station.

Validated parking at Metro Park (nr. 2nd on Mission)

Hours:

Mon. thru Thurs. 10-9

Friday, 10-6

Saturday, 10-5

BOGNER

ELHO

ELLESSE

COLMAR

HEAD

GERRY

BECONTA

SASKA

67 Second St. • San Francisco
362-3676

THE OLD MARKET ANTIQUES

RETAIL
WHOLESALE

AUCTION
or
TAKE ON CONSIGNMENT

1701 Fourth Street
San Rafael 457-1535

300 Sir Francis Drake
San Anselmo 457-0641

Still Verismo

continued from p. 81

For a pleasant dining experience
before or after anything . . .

SALMAGUNDI

San Francisco's
International Gourmet Soup
and Quiche Restaurant

DIRECTLY ACROSS FROM THE GEARY
AND CURRAN THEATRES

Open until Midnight

extra element: the continuous, ironic theme of real life and art paralleling each other. *Pagliacci* is on one level a fable of the theater. It is sprinkled with flourishes upon the fascinating theme of art copying reality. Canio may tell the villagers: "The stage and real life are not the same thing," but we in the audience are already beginning to suspect otherwise. Canio tests the villagers—*Vi pare?* ("Is that how it appears to you?")—with an ironic edge that implicitly tests us in the audience also. When Tonio—a miniature Iago—tells the jealous Canio that "one must dissemble in order to succeed," we realize that "acting" has its place in real life, just as real life will find its way to the stage in the opera's denouement. When the audience for the *commedia* onstage exclaims, "Just as if it were real, this scene!", we grasp the reality of their impression in full tragic perspective. Only as Canio announces over the two bodies that "La *commedia* è finita!" do the two perspectives of stage and actual audience unite. The shading from theater into life is complete. These last words of Canio, full of the weight of real life and despair, are the *verismo* equivalent of Prospero's "Our revels now are ended. . . ."

Gary Schmidgall's book, *Literature as Opera*, will be published by Oxford University Press in the fall of 1977.

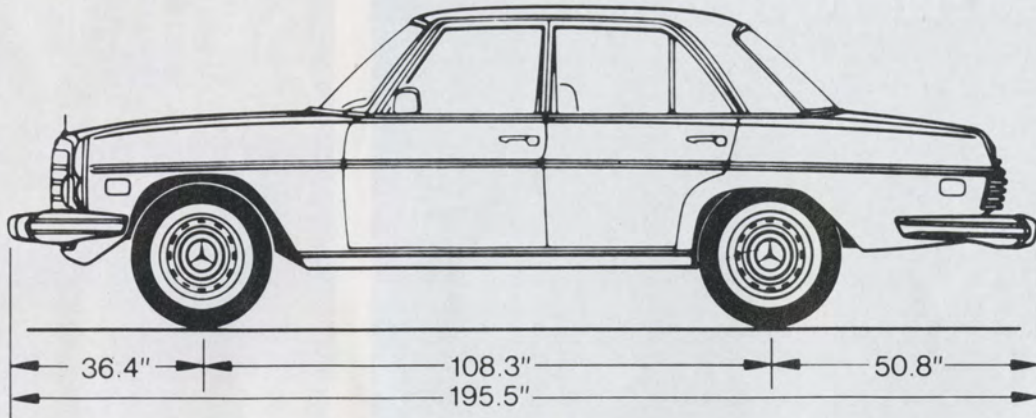

**Come and test drive
the Mercedes-Benz 280.
See for yourself why it's the most
copied sedan in the world.**

Our competitors seem to like the Mercedes-Benz 280 almost as much as we do. They have models which try to look like it. They even say they have cars which drive like it. Yet no domestic sedan combines the fundamental engineering features of the 280.

Frankly, we question their claims. But you can decide for yourself. Test drive the Mercedes-Benz 280. Then compare it to any other sedan. See why it's the most copied sedan in the world.

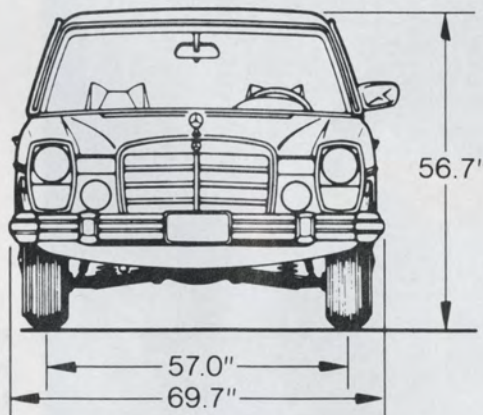

**EUROPEAN MOTORS
MERCEDES-BENZ** 

Specialists in Selling • Servicing • Leasing • Overseas Delivery

1740 Van Ness Avenue, San Francisco
673-9109

2915 Broadway, Oakland
832-6030

EVEN NAPOLEON REALIZED YOU CAN'T WIN
EVERYTHING WITH AN ARMY.

San Francisco Opera 1976 Poster



Discover Napoleon's legendary grand passion, the uniquely light blending of the essence of Andalusian tangerines and superb cognac. Since 1803, it has justly been La Grande Liqueur Imperiale.

Mandarine Napoléon Liqueur

For free recipe book, "Fire 'n' Ice", write to: Somerset Importers, Ltd., Dept. SP,
100 Park Ave., N.Y. 10017. 80 Proof. Imported by Somerset Importers, Ltd., N.Y.

The San Francisco Opera 1976 poster, designed by Browning Graphics, represents a stylized portion of a curtain being drawn back to symbolically reflect the opening of the season.

The graphic is a silk screen using three colors—silver, blue and black—diecut at the bottom to indicate the ruffle of the curtain.

The poster has been prepared in two versions: in a 13" x 39" format, on sale at the Opera Box Office for \$10.00, and a 23¼" x 70" collector's special edition for \$75.00. Information on the special edition may be obtained by contacting the Opera public relations department.

San Francisco Opera 1976

Earl Westcott, Artistic, General Director

WEDNESDAY	THURSDAY	FRIDAY	SATURDAY	SUNDAY
	September 10	11	12	
15	16	17	18	19
22	23	24	25	26
29	30	October 1	2	3
6	7	8	9	10
13	14	15	16	17
20	21	22	23	24
27	28	29	30	31
3	4	5	6	7
10	11	12	13	14
17	18	19	20	21
24	25	26	27	28

“A man has the right to know what goes into the Scotch he drinks.”

—Sir James Buchanan

“At the House of Buchanan, we still believe and blend as my grandfather did.

“It is a family tradition.

“A matter of family pride.

“Pride in the excellence of the blend which bears my grandfather’s name and mine, *Buchanan’s 12*.”



Sir James Buchanan (Lord Woolavington) 1849-1935 Founder of The House of Buchanan

“That is why, unlike any premium blended Scotch whisky ever sold in America, we take pride in naming the principal single malts which, among other exceptional whiskies, go into our blend.

“If you know fine Scotch, you will recognize them all.

“The selection is choice.

“Limited to 12 ‘Ideals’.

“Each the product of an old, established and well respected distillery.

“Each and every one, from Balmenach through Teaninich, is a Highland whisky.

“And two, Cragganmore and Dailuaine, are cherished products of the famed Glenlivet region.



“Together they combine to make *Buchanan’s 12* the 12-year-old blended Scotch with ‘a heart of Highland whiskies’.

“You will find it as it was when it began:

“Subtle.

“Light.

“But with tempered mellowness in both body and bouquet.

“In your country, it is dearly priced. “And in limited supply.

“So limited that I invite you to call this toll free number to obtain assistance in locating the *Buchanan’s 12* purveyors nearest you.

“800-243-9188.

“Because we neither can, nor will, mass-produce the Scotch that bears my grandfather’s name.

“And mine.”

James Buchanan



Buchanan’s 12. The Blend of Ideals.

Blended Scotch Whisky 86.8 Proof, Heublein, Inc. Hartford, Conn.

San Francisco Opera Broadcast Schedule

San Francisco
KKHI 1550 AM
95.7 FM

Fresno	KMJ	97.9 FM
Los Angeles	KFAC	1330 AM/92.3 FM
Portland	KOIN	101.1 FM
Sacramento	KFBK	92.5 FM
San Diego	KFSD	94.1 FM
Seattle	KING	98.1 FM

FRIDAYS 7:50 P.M.*

- September 10 Thaïs — Opening Night
- September 17 Die Walküre (7:20 P.M.)*
- September 24 La Forza del Destino
- October 8 Tosca
- October 15 Die Frau ohne Schatten
- October 22 Peter Grimes
- October 29 The Makropulos Case
- November 5 Cavalleria Rusticana and I Pagliacci
- November 12 Il Barbiere di Siviglia
- November 26 Angle of Repose

Broadcasts live and in quadraphonic sound are made possible by grants from the L. J. and Mary C. Skaggs Foundation of Oakland, California and Standard Oil Company of California.

In addition to inviting you to listen to this year's opera broadcasts, we at Standard would also like to take this opportunity to invite you to visit our Chevron Gallery at 555 Market Street in San Francisco weekdays from 9 a.m. to 4 p.m.

An exhibit honoring San Francisco's major performing arts organizations —The American Conservatory Theatre, and San Francisco's Ballet, Opera and Symphony—will be on display through September 30. Featured are costume and set designs as well as contemporary and historical memorabilia.



Standard Oil Company of California

San Francisco Opera

	Monday	Tuesday
September		Die Walküre 7:30 pm A,B
	13	14
	20	La Forza del Destino 8 pm A,B
October	27	Thaïs 8 pm B
	4	28
	11	Tosca 8 pm A,C
November	18	5
	25	12
	1	Die Frau ohne Schatten 8 pm A,C
	8	19
	15	The Makropulos Case 8 pm A,B
	22	26
		Die Frau ohne Schatten 8 pm D,F
		Angle of Repose 8 pm A,C
		Cavalleria Rusticana/ I Pagliacci 8 pm A,C
		Il Barbiere di Siviglia 8 pm A,C
		2
		9
		16
		23

Code letters indicate subscription series

*Special non-subscription Thanksgiving Night performance

1976 Calendar

Wednesday	Thursday	Friday	Saturday	Sunday
		Opening Night Thäis 8 pm A	Die Walküre 7:30 pm J,K	
		10	11	12
Thäis 8 pm D,F		Die Walküre 7:30 pm G,H	La Forza del Destino 8 pm J,L	Thäis 2 pm M,N
15	16	17	18	19
Die Walküre 7:30 pm D,E		La Forza del Destino 8 pm G,I	Thäis 8 pm J,K	Die Walküre 1:30 pm M,O
22	23	24	25	26
La Forza del Destino 8 pm D,E		Thäis 8 pm G,I	Die Walküre 1 pm X Tosca 8 pm J,L	La Forza del Destino 2 pm O
29	30	1	2	3
Peter Grimes 8 pm D,F		Tosca 8 pm G,H	Peter Grimes 8 pm J,K	Tosca 2 pm M,N
6	7	8	9	10
Peter Grimes 8 pm A,C		Die Frau ohne Schatten 8 pm G,I	Tosca 8 pm D,F	Peter Grimes 2 pm M,N
13	14	15	16	17
The Makropulos Case 8 pm D,E		Peter Grimes 8 pm G,H	Tosca 1:30 pm X The Makropulos Case 8 pm J,L	Die Frau ohne Schatten 1:30 pm M,N
20	21	22	23	24
Cavalleria Rusticana/ I Pagliacci 8 pm D,F		The Makropulos Case 8 pm G,I	Cavalleria Rusticana/ I Pagliacci 1:30 pm X Die Frau ohne Schatten 8 pm J,L	The Makropulos Case 2 pm M,O
27	28	29	30	31
		Cavalleria Rusticana/ I Pagliacci 8 pm G,H	Angle of Repose 8 pm J,K	La Forza del Destino 2 pm M,N
3	4	5	6	7
Cavalleria Rusticana/ I Pagliacci 8 pm B	Fol de Rol 8:30 pm	Il Barbiere di Siviglia 8 pm G,I	La Forza del Destino 1:30 pm X Cavalleria Rusticana/ I Pagliacci 8 pm J,L	Angle of Repose 2 pm M,N
10	11	12	13	14
Il Barbiere di Siviglia 8 pm E	Angle of Repose 8 pm D,F	La Forza del Destino 8 pm H	Il Barbiere di Siviglia 8 pm J,K	Cavalleria Rusticana/ I Pagliacci 2 pm M,O Leontyne Price Recital 8 pm
17	18	19	20	21
Cavalleria Rusticana/ I Pagliacci 8 pm E	Il Barbiere di Siviglia* 8 pm	Angle of Repose 8 pm G,H	Cavalleria Rusticana/ I Pagliacci 8 pm K	Il Barbiere di Siviglia 2 pm M,O
24	25	26	27	28

MANDARIN OPERA



LUNCH DINNER

RESTAURANT

336 Hayes St., San Francisco
(One block behind opera house)
(415) 621-9640

KIM'S SPA

Oriental Ambience

Open 12-12

397-4104

441 Stockton, S.F.
1 Block from Union Square



India house
Since 1947

DISTINCTIVE CUISINE OF INDIA
LUNCHEON · COCKTAILS · DINNER
RESERVATIONS ACCEPTED 392-0744
VALET PARKING · BANQUET ROOMS AVAILABLE
350 JACKSON/SANSOME, SAN FRANCISCO

ONE OF SAN FRANCISCO'S MOST
FASCINATING MARKET PLACES
For the beautiful and unique . . . From Jewelry
and artifacts to Rugs and Handcrafts.



Antique American Hand Made Quilt

 THE MUSEUM SHOP
3119 FILLMORE ST.
SAN FRANCISCO

ADVERTISERS

Angel Records
Ambassador Health Club
American Airlines

Bank of America
Bardelli's
Bay Meadows
Bayview Federal Savings
Beefeater
Belrose Studio Theatre
Benson & Hedges
Beppino's
Blue Boar Inn
Fred Braun
Britex
Buchanan Scotch
The Buena Vista
Bullshot Crummond

Cadillac
Cafe Sn. Marcos
Canlis
Can-Can
The Caprice
Caravansary
Carlton Cigarettes
Carnelian Room
Castenada West
Chanel
Fred Cherry
Chez Marguerite
Citizen Savings and Loan Association
Cuervo Gold
Cresalia Jewelers

Dance Coalition
Del Monte Lodge
Paul de Vries
Jimmy Diamond
Mara Diamond
Le Domino Country Club
Doro's
Down Under
Dunhill Cigarettes
La Mere Duquesne

Ernie's
European Motors
Exprinter International

Fanny's
Fickle Fox
Fox's

Gateway-Richlieu Theatres
Geyser Peak Wines
Gilbert Galleries
Givenchy Gentleman
Golden Gate Geographic Society

where elegance is natural

Castaneda West

largest selection
dresses, formals & pantsuits
with famous East Coast labels

for the woman who knows clothes

SUPER DISCOUNT
Master Charge · BankAmericard

375 Sutter Street
(one block off Union Square)
7th Floor
San Francisco
391-6252

New York · Wash. D.C. · Miami · Puerto Rico



THE FICKLE FOX

San Francisco's most unique Dinner House

Featuring at our Piano Bar
Denis Moreen & Frank Jackson

Serving Dinner Nightly 6 - 11 p.m.
Sunday Brunch 11:30 - 3:30
842 Valencia St. bwt 19th & 20th
826-3373 Reservations Suggested.



Blue Boar Inn

AFTER THEATRE DINNER TILL 1 a.m.
1713 LOMBARD STREET · SAN FRANCISCO · 567-8424
DINNER NIGHTLY 6 p.m. - 1 a.m.

San Francisco Bay Area
Dance Coalition presents

10 WEEKENDS OF DANCE

Featuring 30 companies,
Friday and Saturday
evenings, October 15 through
December 18, 8:30 pm, at
Gumption, 1563 Page (at
Masonic), San Francisco.
Advanced Tickets and
information, 673-8172

ANTIQUES and
this fresh new table



WOODLING

3310 Sacramento St., S.F. 922-0440

The Golden Pavilion
The Graf Zeppelin
Grison's
Grubb & Ellis

A. Hagosian & Son
Harcourt Gallery
Helga Howie
Hotel Mark Hopkins
House of Charms
Hugo's One Up (Hyatt on Union
Square)
Hyatt Regency

Pasquale Iannetti, Inc. Gallery
Imperial Palace
India House
Innisfree

J & B Rare Scotch

Kalliope
Kan's
Kashian Persian Rugs
Kendurina
Kenneallys
Kim's Spa
Knabe Piano
KGO News/Talk

Paul Langley & Company
Lehr's Greenhouse
Little Fox Theatre

Maison Mendesolle
Malaysia
Mandarine Napoleon Liqueur
Mandarin Opera Restaurant
Mandy's Jewelry
McGuire
Medical Pool
Metes & Bounds
Metro Rent-A-Car
Sidney Mobell
The Museum Shop

Narsai's
Nathan Gallery
The Neighborhood
The Brasserie
(The Fairmont)
New Zealand Government
Tourist Office
North China Restaurant
Now Cigarettes

The Obelisk
L'Odeon
Old Brittany

GEORGE MARDIKIAN'S

*Omar
Khayyam's*

WORLD FAMOUS
SAN FRANCISCO LANDMARK
FEATURING
ARMENIAN/MIDDLE EASTERN
AMERICAN DINING PLEASURES
781-1010
CORNER O'FARRELL & POWELL
SAN FRANCISCO

PARADISE

New Concept in Dining Experience

Open for
Breakfast
Lunch
Dinner

6 a.m. till 2 a.m.

Everyday of the year

2500 Market Street • San Francisco 94114
552-2500 or 552-2501
An Experience You Won't Forget

PIANO ROLLS SHEET MUSIC

The Largest Selection
of Music in the West

**PACIFIC COAST
MUSIC, INC.**
at Sherman Clay

141 Kearny Street near Sutter
Lower Level 781-6023

METRONOMES BOOKS ON MUSIC

IMPORTS
GUITARS
GIFTS

SCORES AND LIBRETTI

North  China

Exquisite Northern Chinese Cuisine
2315 Van Ness Avenue
San Francisco, California 94109
673-8201
Lunch 11:30 - 2 Dinner 4 - 10:00
Closed Sunday

ANTIQUES

ONE OF THE BAY AREA'S
FINEST SELECTIONS OF
18th & 19th CENTURY
ENGLISH & FRENCH COUNTRY
ANTIQUES & REPRODUCTIONS

THE neighborhood

3917 Grand Ave., Oakland/Piedmont
655-1771

**The Finest
Seafood Dining**

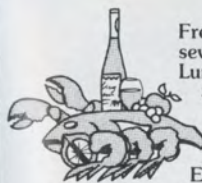

Fresh seafood dinners
seven nights a week.
Lunches and
Sunday brunch
with a fabulous view
of the Bay Bridge.
Pier 2 on the
Embarcadero,
just south of the
Ferry Bldg.
781-2555

Sinbad's

Down Under

RESTAURANT

Steaks • Sea Food • Salad Bar

Cocktails

LUNCH DINNER
11:30 - 3 p.m. 5:00 p.m.

619 TAYLOR ST., S. F.
771-4378

1 Block from Geary-Curran
Theatres

Bank Credit Cards Accepted



Mandy's
JEWELRY
DESIGN • MFG.

EXQUISITE BURMA JADES
BAROQUE PEARLS AND
OTHER PRECIOUS GEMS

Downtown Oakland
365 17th St., Oakland, Ca., 94612 • 832-1202

Old Brittany

French Restaurant
& Crêperie Bretonne

LUNCH
DINNER
COCKTAILS

Ideal for pre-opera dining

At The Cannery
2801 Leavenworth 776-6996

Paul Langley & Company
San Francisco

Professional
Service
At
The
Heartbeat
Of
San
Francisco

Real Estate Investments
Management Specialists
4111 18th St. at Castro 621-8450

Specializing in Crepes and Liqueured Coffees
Serving Light Lunches and Light Dinners
2367 Market St. | San Francisco | 861-3846
Closed Monday

Old Market
Omar Khayyam's
Opera Education West
L'Orangerie
Orpheus

Pacific Coast Music
Pacific Far East Lines
Panacenters, Inc.
Paradise
Pasha's
The Pavilion
The Penthouse (Hotel St. Francis)
Persian Imports
Pier 54
Place Pigalle
Prophet Foods

Royal Gate Vodka

Salmagundi
San Francisco Antique Show
Schneider Bros.
Seagram's
Sea Witch
John Simmons
Sinbad's
Singles in Concert
Sotheby Parke Bernet Inc. S.F.
Specs
Standard Oil Company of California
Status Thimble
David Stephan
Stewart's Treasure House
Suehiro
Superscope

Tante Marie Cooking School
Telegraph Landing
Vincent Taylor
Trader Vic's

University of California Committee
for Arts and Lectures
U.S. Audio & Copy Corp.
United States Steel

Mario Valentino
Victor's (Hotel St. Francis)
Volvo

Walnuts & Wine
The Waterfront
Wells Fargo Bank
The White Elephant Restaurant
Woodling

Yianni
Zenith

BULLSHOT CRUMMOND

from that same troupe who gave us
"EL GRANDE DE COCA COLA."

HIPPODROME THEATRE
412 Broadway, San Francisco
BOX OFFICE (415) 982-2343

Le Domino
COUNTRY CLUB

French Restaurant & Bar
Dinner 6:15 - 11 pm

presents
HASTINGS & TRANTHUN
IN A BRAND NEW SHOW
Thurs., Fri., Sat. 9:30 - 1:00

2742 17th Street • 626-3095
Closed Sunday

4230 Eighteenth Street
San Francisco

International Dinners from 6:00 p.m. Daily
Saturdays and Sundays, Country Style Brunch
11:30 - 3:00 p.m.

Reservations 621-5570

BERT FARBER'S "ON THE WATERFRONT"
PIER 54 China Basin Road
398-7846

LUNCH - MONDAY thru FRIDAY
DINNER - 7 DAYS A WEEK
BRUNCH - SAT & SUN 11 - 2:30

Featuring the BEST food in town, served by the NICEST people, in the FUNKIEST atmosphere, on the HARDEST chairs in San Francisco. LOTS of FREE parking.

There's golf. And then there's the 18th at Pebble Beach.
There's whisky. And then there's V.O.

Only V.O. is V.O. The First Canadian

CANADIAN WHISKY. A BLEND OF CANADA'S FINEST WHISKIES. 6 YEARS OLD. 96.8 PROOF. SEAGRAM DISTILLERS CO., N.Y.C.



Of all menthols:

Carlton is lowest.

See how Carlton stacks down in tar.
Look at the latest U.S. Government figures for:

The 10 top selling cigarettes

	tar mg./ cigarette	nicotine mg./ cigarette
Brand P Non-Filter	27	1.7
Brand C Non-Filter	24	1.5
Brand W	19	1.3
Brand S Menthol	19	1.3
Brand S Menthol 100	19	1.2
Brand W 100	18	1.2
Brand M	18	1.1
Brand K Menthol	17	1.3
Brand M Box	17	1.0
Brand K	16	1.0

Other cigarettes that call themselves low in "tar"

	tar mg./ cigarette	nicotine mg./ cigarette
Brand D	15	1.0
Brand P Box	14	0.8
Brand D Menthol	14	1.0
Brand M Lights	13	0.8
Brand W Lights	13	0.9
Brand K Milds Menthol	13	0.8
Brand T Menthol	11	0.7
Brand T	11	0.6
Brand V Menthol	11	0.8
Brand V	11	0.7
Carlton Filter	*2	*0.2
Carlton Menthol	*1	*0.1
Carlton 70	*1	*0.1

(lowest of all brands)
*Av per cigarette by FTC method.

**Carlton
Menthol
1 mg. tar**



**Carlton
Filter
2 mg. tar**

No wonder Carlton is the fastest growing of the top 25 brands.

Warning: The Surgeon General Has Determined That Cigarette Smoking Is Dangerous to Your Health.

Menthol: 1 mg. "tar", 0.1 mg. nicotine; Filter: 2 mg. "tar", 0.2 mg. nicotine; Carlton 70's: 1 mg. "tar", 0.1 mg. nicotine av. per cigarette by FTC method.

Cavalleria Rusticana
and I Pagliacci

San
Francisco
Opera

Kurt Herbert Adler, general director

54th Season
September 10 through November 28, 1976
War Memorial Opera House

New Production made possible, in part, by a generous
gift from James D. Robertson

Cavalleria Rusticana

(IN ITALIAN)

by PIETRO MASCAGNI

to a text by GIOVANNI TARGIONI-TOZZETTI and GUIDO MENASCI

Based on the play by GIOVANNI VERGA

Conductor
Kenneth Schermerhorn
Production Designed and Directed by
Jean Pierre Ponnelle
Assistant to Mr. Ponnelle
Jean Louis Martinoty**
Chorus Director
Robert Jones
Lighting Designer
Thomas Munn
Musical Preparation
Randall Bare
Scenery Built in
San Francisco Opera Scenic Shop
Costumes Executed by
Günter Berger, Director,
and
Sylvia Strahammer,
Costume Department
Bavarian State Opera
San Francisco Boys Chorus
William Ballard, Director

CAST

(in order of appearance)

Santuzza Tatiana Troyanos (October 27, 30,
November 5, 10, 13)
Regine Crespin (November 16, 21, 24, 27)

Turiddu Placido Domingo (October 27, 30,
November 5, 10, 13, 16)
Juan Lloveras (November 21, 24, 27)

Mamma Lucia Donna Petersen

Alfio Wassili Janulako

Lola Faith Esham*

Peasants and villagers

**American debut

*San Francisco Opera debut

TIME AND PLACE: EASTER SUNDAY, A VILLAGE IN SOUTHERN ITALY

First Performance: Rome, May 17, 1890

First San Francisco Opera Performance: September 24, 1927

followed by

New Production made possible, in part, by a generous
gift from James D. Robertson

I Pagliacci

(IN ITALIAN)

by RUGGIERO LEONCAVALLO

with text by the composer

Conductor
Kenneth Schermerhorn
Production Designed and Directed by
Jean Pierre Ponnelle
Assistant to Mr. Ponnelle
Jean Louis Martinoty**
Chorus Director
Robert Jones
Lighting Designer
Thomas Munn
Musical Preparation
Randall Bare
Scenery Built in
San Francisco Opera Scenic Shop
Costumes Executed by
Günter Berger, Director,
and
Sylvia Strahammer,
Bavarian State Opera
San Francisco Boys Chorus
William Ballard, Director
Marin County Day School Girls Chorus
Barry Mineah, Director

CAST

(in order of appearance)

<i>Tonio (Taddeo)</i>	Ingvar Wixell (October 27, 30, November 5, 10, 13, 16) Peter Glossop (November 21, 24, 27)
<i>Canio (Pagliaccio)</i>	Placido Domingo (October 27, 30, November 5, 10, 13, 16) Bruno Prevedi (November 21, 24, 27)
<i>Nedda (Columbine)</i>	Noelle Rogers* (October 27, 30, November 5, 10, 13, 16) Raina Kabaivanska (November 21, 24, 27)
<i>Beppe (Harlequin)</i>	Joseph Frank
<i>Two Farmers</i>	James Hoback, John Davies
<i>Silvio</i>	Brent Ellis*
<i>Pantomime by</i>	Paul Scardino* Dennis Parlato* Mary Van Perre*
<i>Peasants and villagers</i>	

**American debut

*San Francisco Opera debut

THE OPERA TAKES PLACE IN A VILLAGE IN SOUTHERN ITALY

First performance: Milan, May 21, 1892

First San Francisco Opera performance: October 6, 1923

WEDNESDAY EVENING, OCTOBER 27, 1976 AT 8:00
SATURDAY AFTERNOON, OCTOBER 30, 1976 AT 1:30
FRIDAY EVENING, NOVEMBER 5, 1976 AT 8:00 (Broadcast)
WEDNESDAY EVENING, NOVEMBER 10, 1976 AT 8:00
SATURDAY EVENING, NOVEMBER 13, 1976 AT 8:00
TUESDAY EVENING, NOVEMBER 16, 1976 AT 8:00
SUNDAY AFTERNOON, NOVEMBER 21, 1976 AT 2:00
WEDNESDAY EVENING, NOVEMBER 24, 1976 AT 8:00
SATURDAY EVENING, NOVEMBER 27, 1976 AT 8:00

Please do not interrupt the music with applause

*Latecomers will not be seated during the performance
after the lights have dimmed in order not to disturb
patrons who have arrived on time*

*The use of cameras and any kind of recording equipment
is strictly forbidden*

*The performance will last approximately
two hours and fifty minutes*

SYNOPSIS

CAVALLERIA RUSTICANA / I PAGLIACCI

CAVALLERIA RUSTICANA

As Easter dawns in a small Italian village, the distant voice of Turiddu, who has abandoned Santuzza, is heard singing the praises of Lola, wife of the prosperous carter Alfio. Santuzza approaches Turiddu's mother, Mamma Lucia, searching for her lover whom she has not been with in some time. Mamma Lucia reveals that her son has gone out of town for a supply of wine, but in fact, Santuzza knows Turiddu was seen in the village that morning. Alfio then enters with villagers, publicly boasting of his new wife, Lola. Confronting Mamma Lucia, Alfio states he saw Turiddu that very morning near his house.

As the Easter procession celebrating the Resurrection files out of the church, the worshippers sing the *Regina Coeli*, while Santuzza tells Mamma Lucia she has been abandoned by Turiddu for Lola, his former sweetheart. When the old woman goes off to Mass, Santuzza stays to confront Turiddu. Their argument is interrupted suddenly when Lola brazenly saunters in. Infuriating Santuzza with her ironic comments, Lola leaves, entering the church. Santuzza resumes her pleading, but Turiddu refuses to listen and, throwing her to the ground, runs into the church. In a fury Santuzza curses him. Having reached that point of unabated jealousy, she seeks out Alfio who awaits his wife's return from Mass. Santuzza tells Alfio he is being cuckolded by Turiddu, and the carter leaves, vowing revenge.

Leaving Mass, Turiddu openly offers wine to Lola, as the villagers join him in a drinking song. Alfio reappears and scornfully refuses wine offered by Turiddu, saying it would poison him. Turiddu accepts the carter's challenge to fight to death, by biting Alfio's ear; Turiddu then requests and is granted a moment with his mother. Left alone with Mamma Lucia, Turiddu bids her a tearful farewell, begging her to care for Santuzza if he does not return. He goes off to fight the duel. Moments later shouts rise in the distance, and people rush into the square crying that Turiddu has been killed.

I PAGLIACCI

In the Prologue, Tonio, a clown in a small theatrical road company, announces that the author has written a true story about actors, who share the same joys and sorrows as other human beings.

On the Feast of the Assumption, a company of touring actors, accompanied by excited villagers, arrive at the outskirts of a small south Italian village. Canio, head of the troupe, announces that the performance will begin at eleven p.m. that evening. When one of the crowd suggests that Tonio is courting Nedda

behind his back, the jealous Canio warns that he tolerates no flirting with his wife. Canio joins a group of villagers and goes off to the nearby inn. The *zampognari* (bagpipers) enter the square and entertain the gathered villagers before they go to the church, leaving Nedda alone in her thoughts. Disturbed by her husband's suspicious glances, she envies the freedom of the birds that soar overhead. Tonio, who has listened to Nedda's reverie, tries to make love to her, but she strikes him, sending him away in a rage. A moment later her lover, the villager Silvio, appears; taking Nedda in his arms, he persuades her to run away with him at midnight. Meanwhile, after spying on them, Tonio leaves to report the tryst to Canio, who returns from the inn and discovers the guilty pair. A chase ensues, but Silvio manages to escape. Though threatened with a knife, Nedda refuses to divulge her lover's name, and Beppe, another actor, has to stay Canio's hand. Tonio advises the enraged husband to wait until evening for vengeance. Alone, Canio laments his lot as an actor, laughing through his tears for the public's amusement.

The villagers assemble to see the play, and Nedda, collecting money for the performance, exchanges some words with Silvio, assuring him of their rendezvous. The *commedia* begins, which is based on the familiar tale of Pagliaccio and Columbine. In the absence of her husband, Pagliaccio (played by Canio), Columbine (Nedda) is serenaded by her lover Arlecchino (Beppe). Together they drive away her servant the buffoon Taddeo (Tonio). Columbine and Arlecchino dine together and plot to poison Pagliaccio, whose approach interrupts their love-making. After Arlecchino has escaped, Taddeo with pointed malice assures Pagliaccio of his wife's innocence. Obsessed with jealousy, Canio forgets he is onstage and demands that Nedda name her lover. She tries to continue the play, as the audience gradually realizes the reality of the situation. Beppe tries to intercede, but Tonio holds him back. Maddened by her continued defiance, Canio stabs Nedda and Silvio, who has rushed forward to help her. Canio cries out that the comedy is ended.

